

PHS 100-1A18 SKF

ANSI sprockets

TYPE: Simplex, Pilot bore without hub, Standard ANSI (SKF)

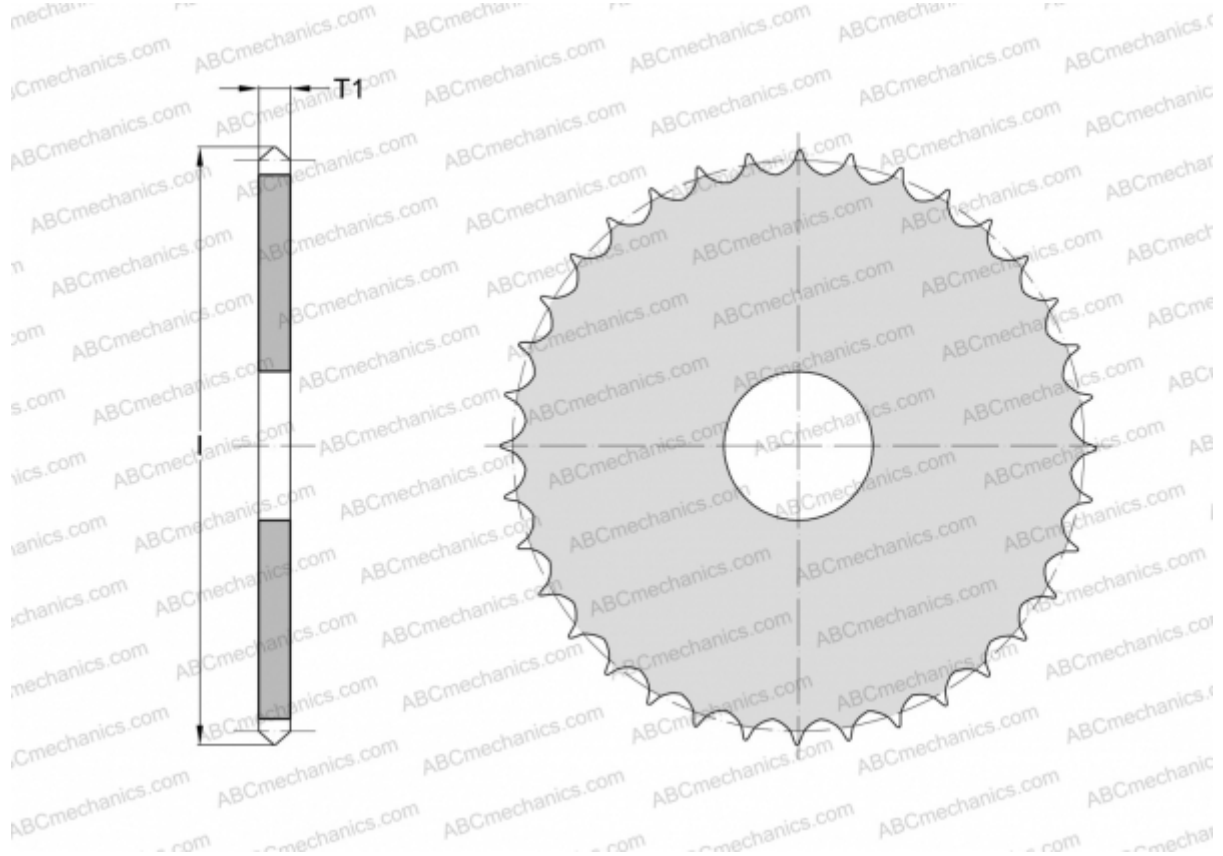

Technical specification

DIMENSIONS, MM

Pitch, p	31,750
Dimensions bore, min	31,750
Thickness, T1	17,570
l	199,136
Number of teeth	18

WEIGHT, KG 3,150

MANUFACTURER [SKF](#)