

PHS 100-1A19 SKF

ANSI sprockets

TYPE: Simplex, Pilot bore without hub, Standard ANSI (SKF)

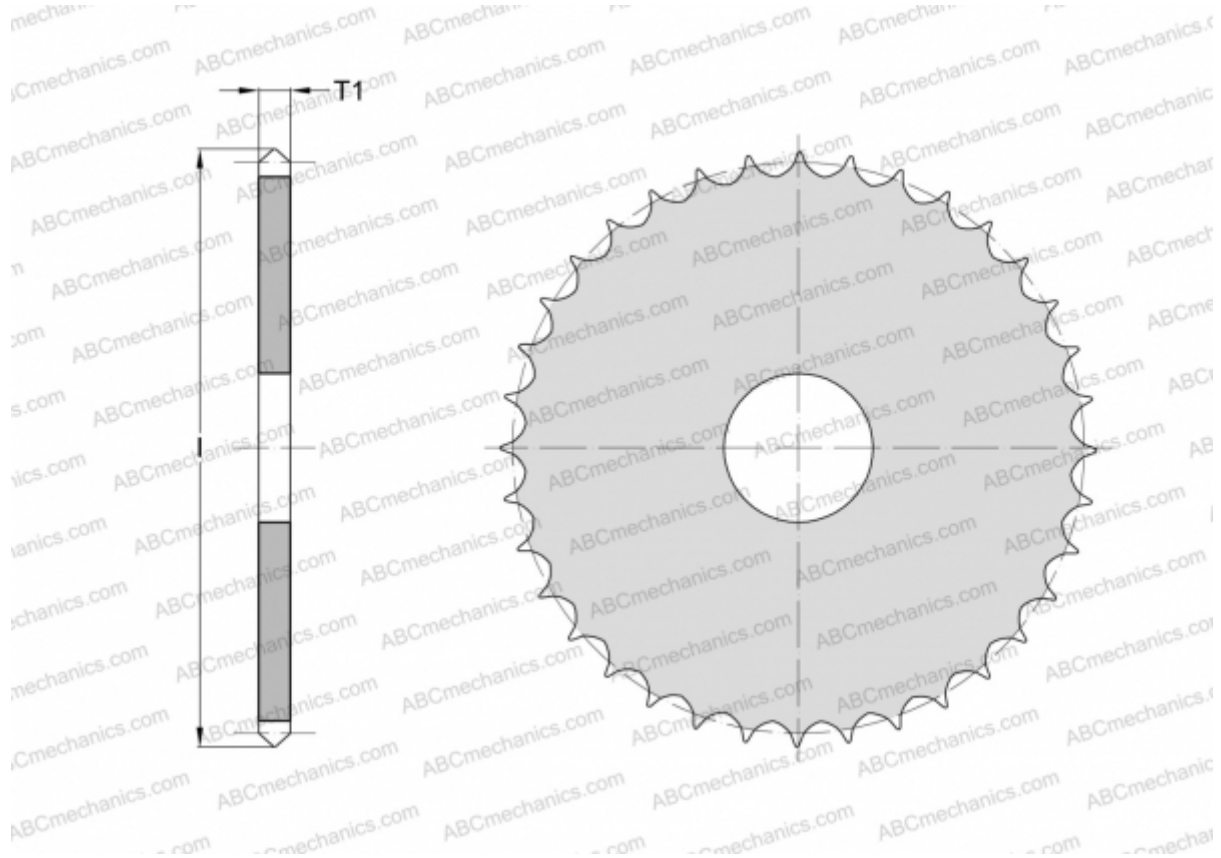

Technical specification

DIMENSIONS, MM

Pitch, p	31,750
Dimensions bore, min	31,750
Thickness, T1	17,570
l	209,296
Number of teeth	19

WEIGHT, KG 3,510

MANUFACTURER [SKF](#)