

## PHS 05B-1B10 SKF

Metric sprockets

TYPE: Simplex, Pilot bore, hub on one side, Standard BS/ISO (SKF)

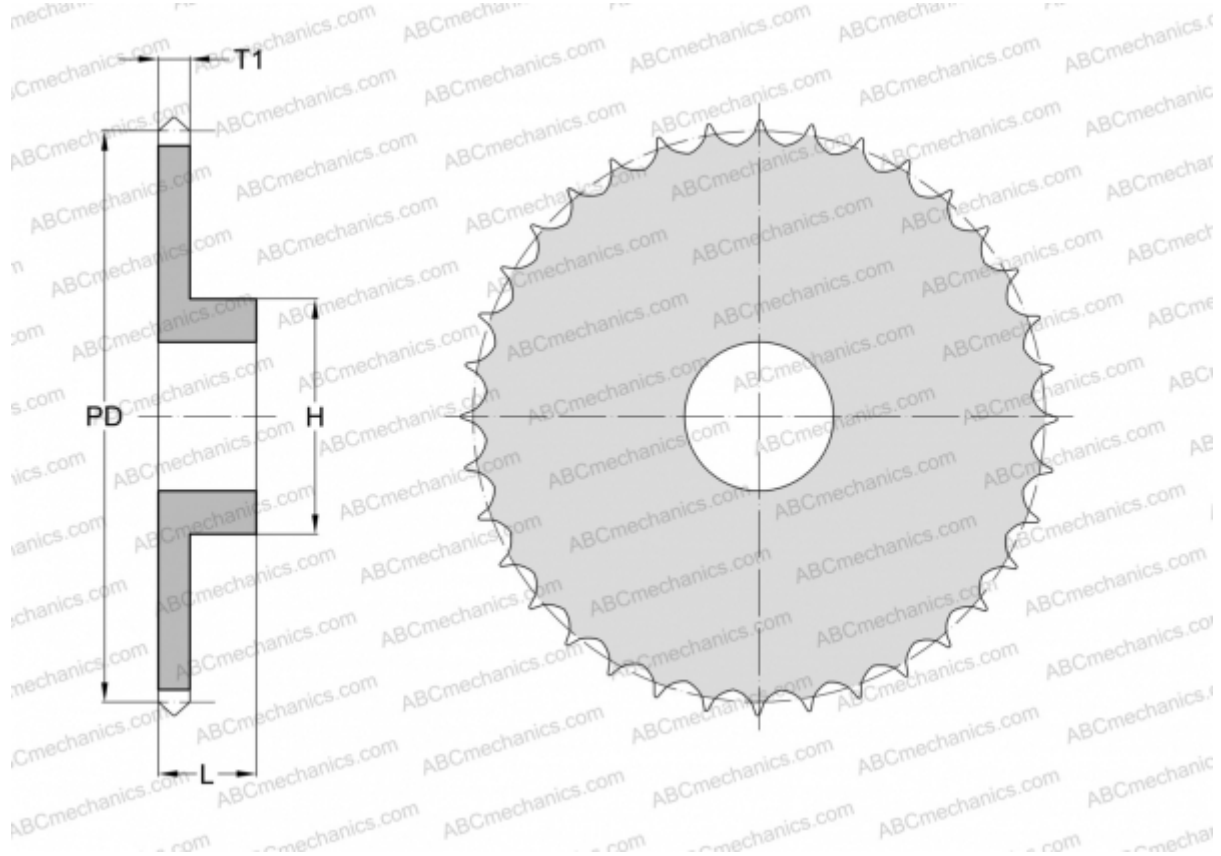

### Technical specification

#### DIMENSIONS, MM

Pitch, p	8,000
Pitch diameter, PD	25,890
Dimensions bore, min	8,000
Dimensions bore, max	8,000
Hub, H	17,000
Thickness, T1	2,800
Number of teeth	10

**WEIGHT, KG** 0,020

**MANUFACTURER** [SKF](#)