

PHS 05B-1B11 SKF

Metric sprockets

TYPE: Simplex, Pilot bore, hub on one side, Standard BS/ISO (SKF)

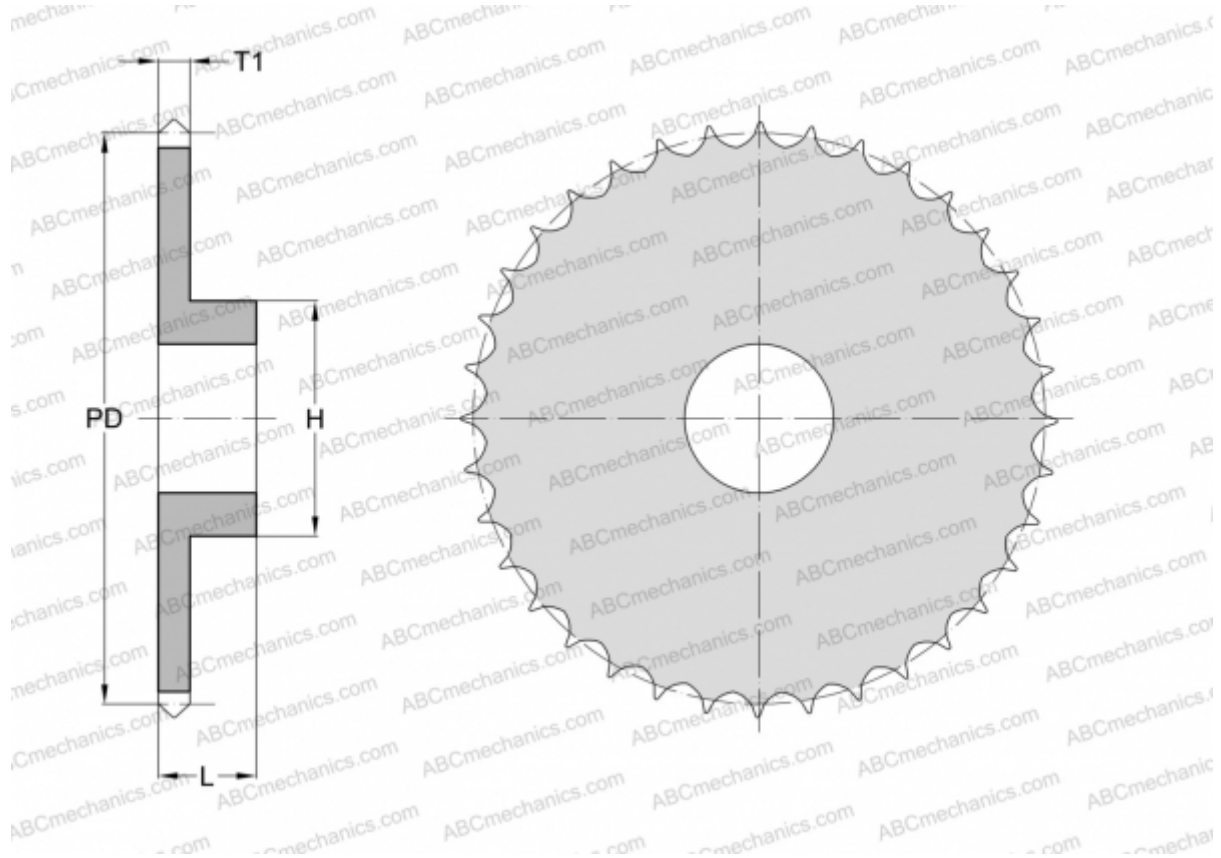

Technical specification

DIMENSIONS, MM

Pitch, p	8,000
Pitch diameter, PD	28,390
Dimensions bore, min	8,000
Dimensions bore, max	8,000
Hub, H	18,000
Thickness, T1	2,800
Number of teeth	11

WEIGHT, KG 0,030

MANUFACTURER [SKF](#)