

SYJ 20 TF SKF

Ball bearing units

TYPE: Housing units, Plummer block, Cast iron housing, Radial insert ball bearing with grub screws in inner ring, Type SY/SYJ..TF (SKF)

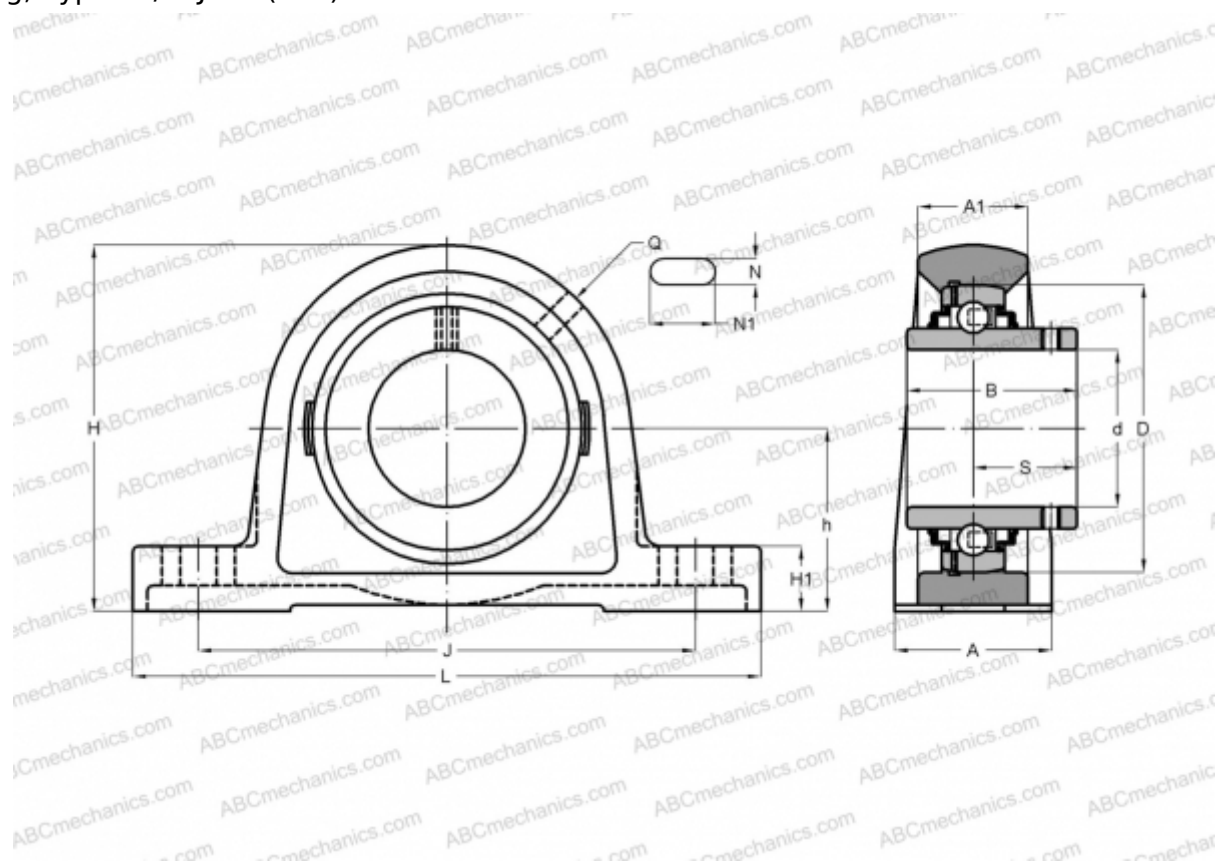

Technical specification

DIMENSIONS, MM

d	20,000
D	47,000
B	31,000
L	127,000
H	65,000
A	34,000
J	97,000
A1	23,000
H1	14,000
N	13,000
N1	20,700
S	18,300
h	33,300

WEIGHT, KG 0,550

Bearing	YAR 204-2F
Housing	SYJ 504

MANUFACTURER

[SKF](#)

CALCULATION DATA

Basic dynamic load rating, C	12,700 kN
Basic static load rating, Co	6,550 kN
Fatigue load limit, Pu	0,280 kN
Limiting speed	8500 r/min