

SYJ 40 TF SKF

Ball bearing units

TYPE: Housing units, Plummer block, Cast iron housing, Radial insert ball bearing with grub screws in inner ring, Type SY/SYJ..TF (SKF)

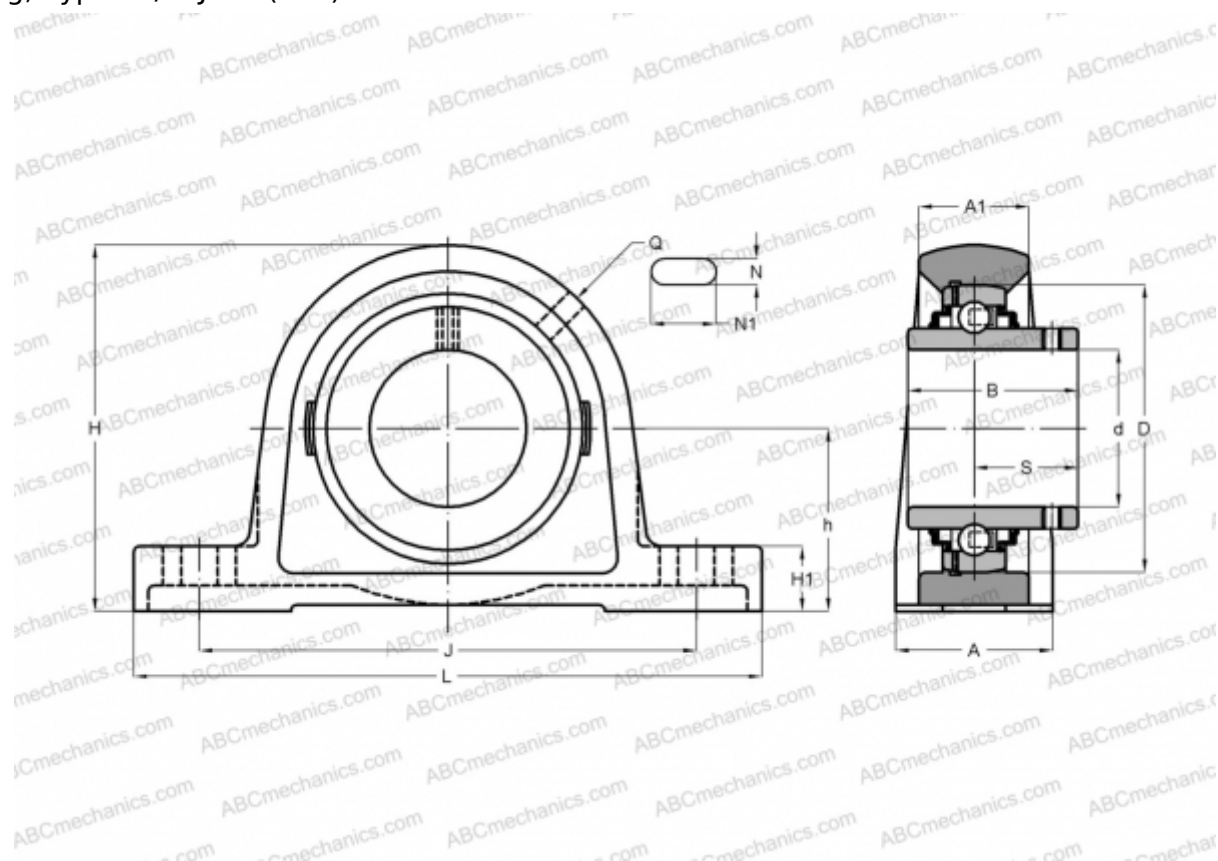

Technical specification

DIMENSIONS, MM

d	40,000
D	80,000
B	49,200
L	184,000
H	99,000
A	49,000
J	136,500
A1	31,000
H1	18,000
N	17,000
N1	25,500
S	30,200
h	49,200

WEIGHT, KG 1,850

Bearing	YAR 208-2F
Housing	SYJ 508

MANUFACTURER

[SKF](#)

CALCULATION DATA

Basic dynamic load rating, C	30,700 kN
Basic static load rating, Co	19,000 kN
Fatigue load limit, Pu	0,800 kN
Limiting speed	4800 r/min