

SYJ 45 TF SKF

Ball bearing units

TYPE: Housing units, Plummer block, Cast iron housing, Radial insert ball bearing with grub screws in inner ring, Type SY/SYJ..TF (SKF)

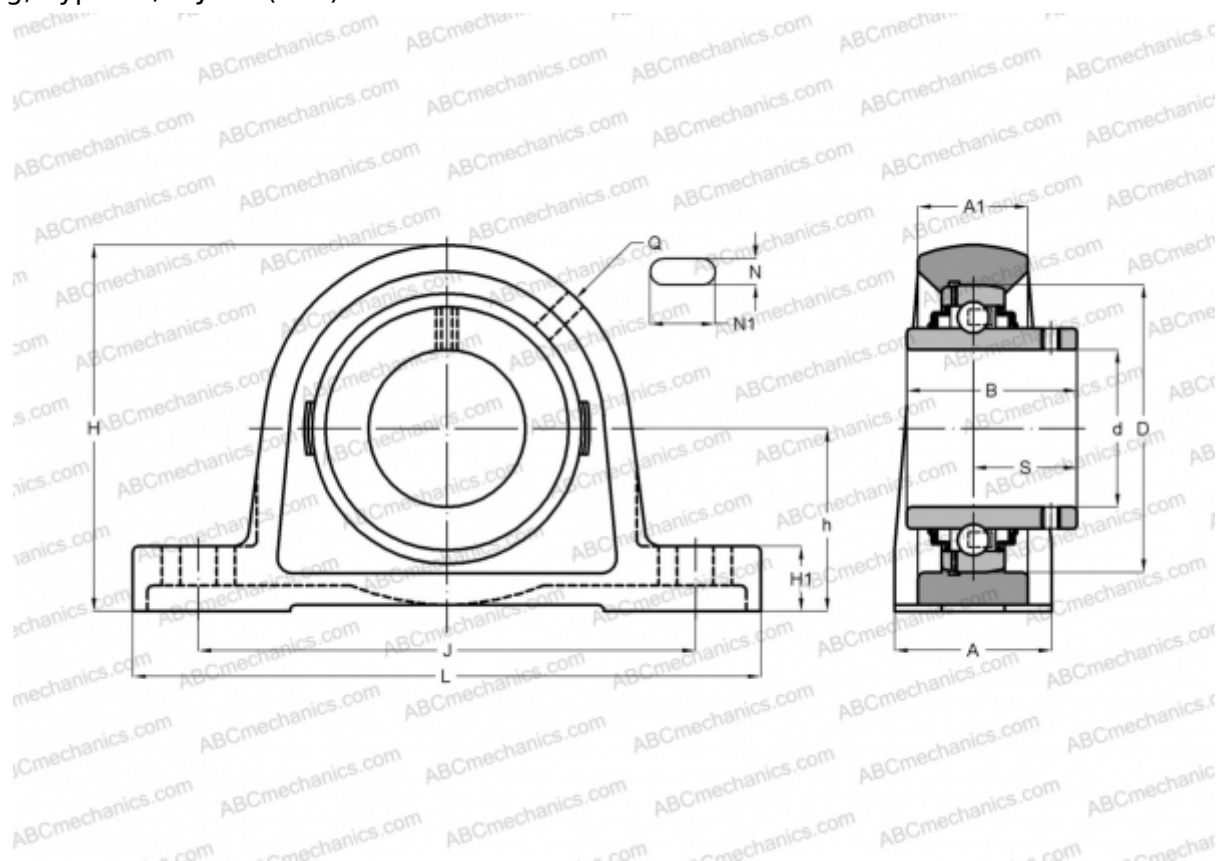

Technical specification

DIMENSIONS, MM

d	45,000
D	85,000
B	49,200
L	190,000
H	107,500
A	52,000
J	143,500
A1	36,000
H1	20,000
N	17,000
N1	23,500
S	30,200
h	54,000

WEIGHT, KG 2,400

Bearing	YAR 209-2F
Housing	SYJ 509

MANUFACTURER

[SKF](#)

CALCULATION DATA

Basic dynamic load rating, C	33,200 kN
Basic static load rating, Co	21,600 kN
Fatigue load limit, Pu	0,915 kN
Limiting speed	4300 r/min