

SY 40 TR SKF

Ball bearing units

TYPE: Housing units, Plummer block, Cast iron housing, Radial insert ball bearing with grub screws in inner ring, Type SY..TR (SKF)

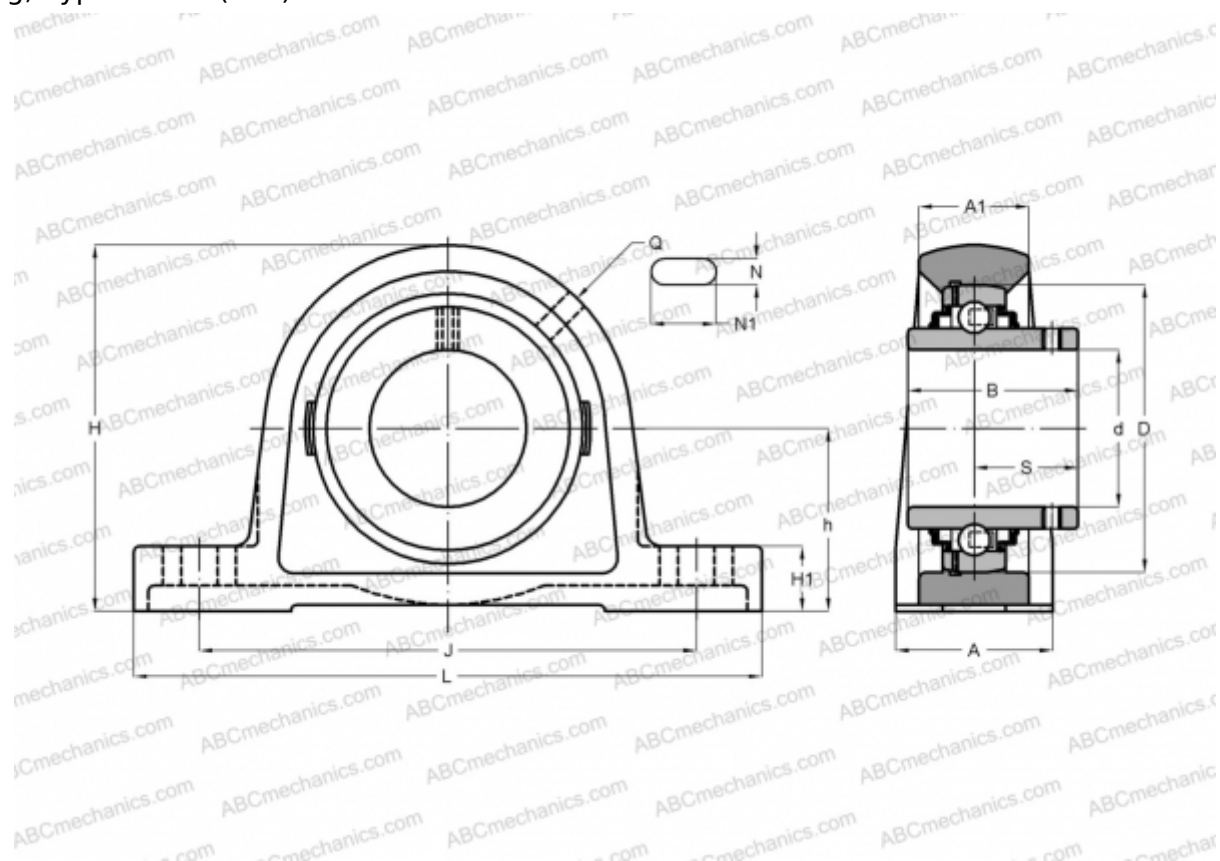

Technical specification

DIMENSIONS, MM

d	40,000
D	80,000
B	49,200
L	175,000
H	99,000
A	48,000
J	135,500
A1	30,000
H1	19,000
N	14,000
N1	24,500
S	30,200
h	49,200

WEIGHT, KG 1,800

Bearing	YAR 208-2RF
Housing	SY 508 M
Protective cover	ECY 208

MANUFACTURER

[SKF](#)

CALCULATION DATA

Basic dynamic load rating, C	30,700 kN
Basic static load rating, Co	19,000 kN
Fatigue load limit, Pu	0,800 kN
Limiting speed	2800 r/min