

SY 5/8 TF SKF

Ball bearing units

TYPE: Housing units, Plummer block, Cast iron housing, Radial insert ball bearing with grub screws in inner ring, Type SY/SYJ..TF (SKF), inch

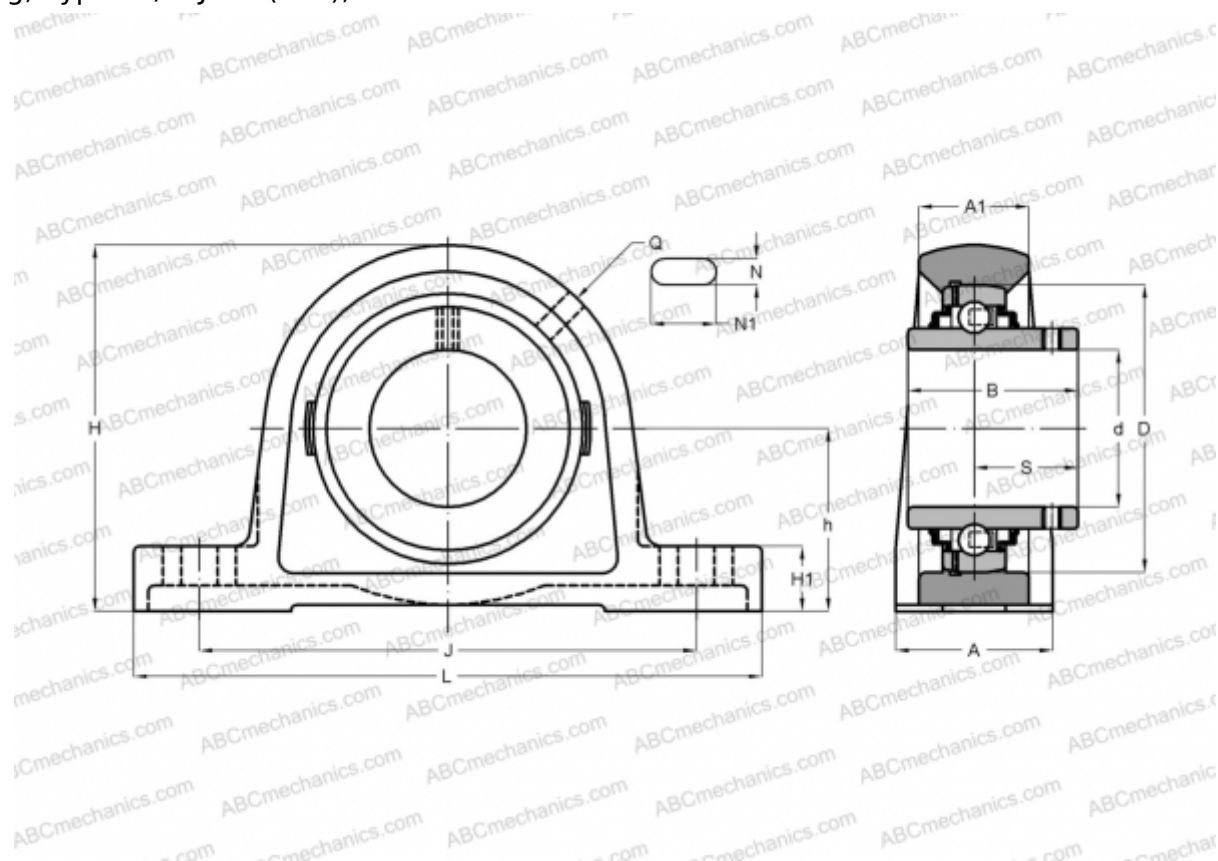

Technical specification

DIMENSIONS, MM

d	15,875
D	40,000
B	27,400
L	127,000
H	56,000
A	32,000
J	97,000
A1	18,000
H1	14,000
N	11,500
N1	20,500
S	15,900
h	30,200

WEIGHT, KG 0,510

Bearing	YAR 203-010-
Housing	SY 503 U

MANUFACTURER

[SKF](#)

CALCULATION DATA

Basic dynamic load rating, C	9,560 kN
Basic static load rating, Co	4,750 kN
Fatigue load limit, Pu	0,200 kN
Limiting speed	9500 r/min