

SYF 35 TF SKF

Ball bearing units

TYPE: Housing units, Plummer block, Narrow cast iron housing, Radial insert ball bearing with grub screws in inner ring, Type SYF/SYFJ..TF (SKF)

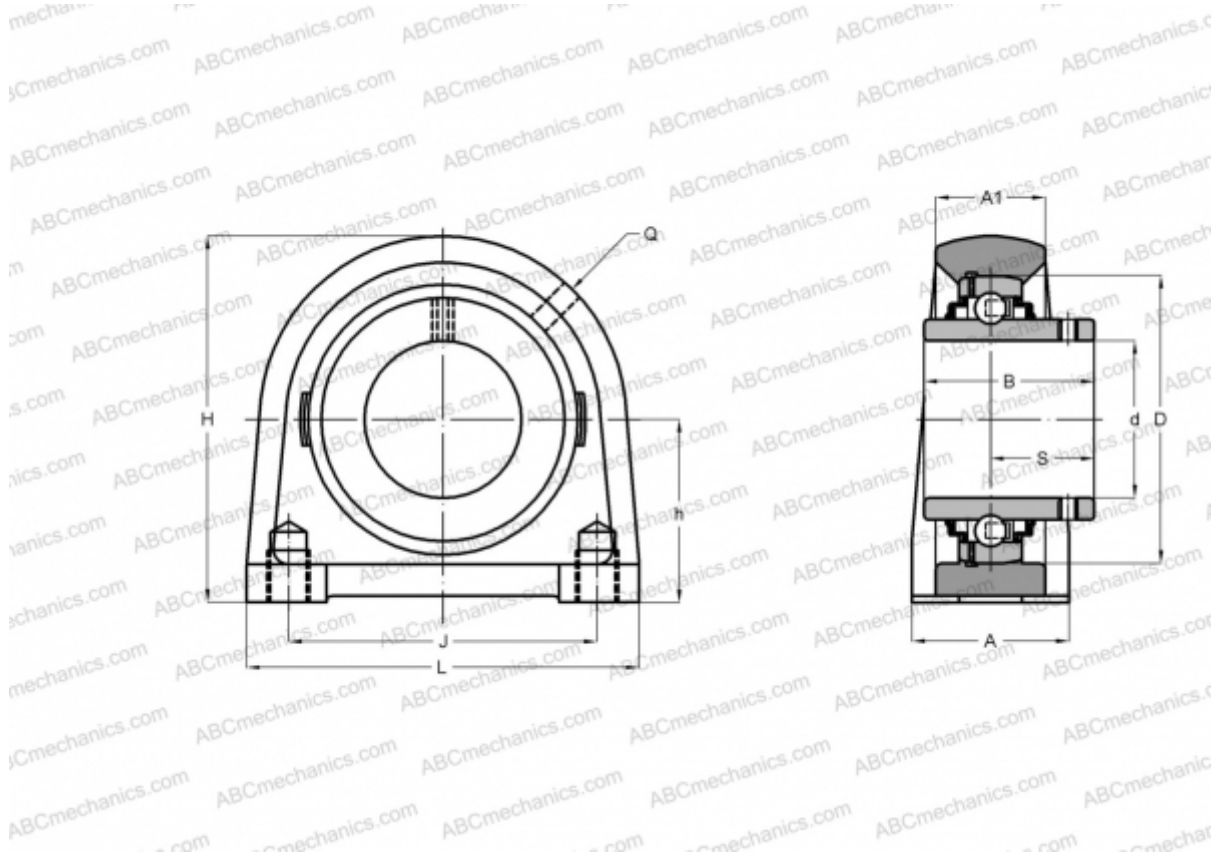

Technical specification

DIMENSIONS, MM

d	35,000
D	72,000
B	42,900
L	103,000
H	93,000
A	45,000
J	82,600
A1	27,000
S	25,400
h	47,600

WEIGHT, KG

1,200

Bearing	YAR 207-2F
Housing	SYF 507

MANUFACTURER

[SKF](#)

CALCULATION DATA

Basic dynamic load rating, C	25,500 kN
Basic static load rating, Co	15,300 kN
Fatigue load limit, Pu	0,655 kN
Limiting speed	5300 r/min