

SYFJ 35 TF SKF

Ball bearing units

TYPE: Housing units, Plummer block, Narrow cast iron housing, Radial insert ball bearing with grub screws in inner ring, Type SYF/SYFJ..TF (SKF)

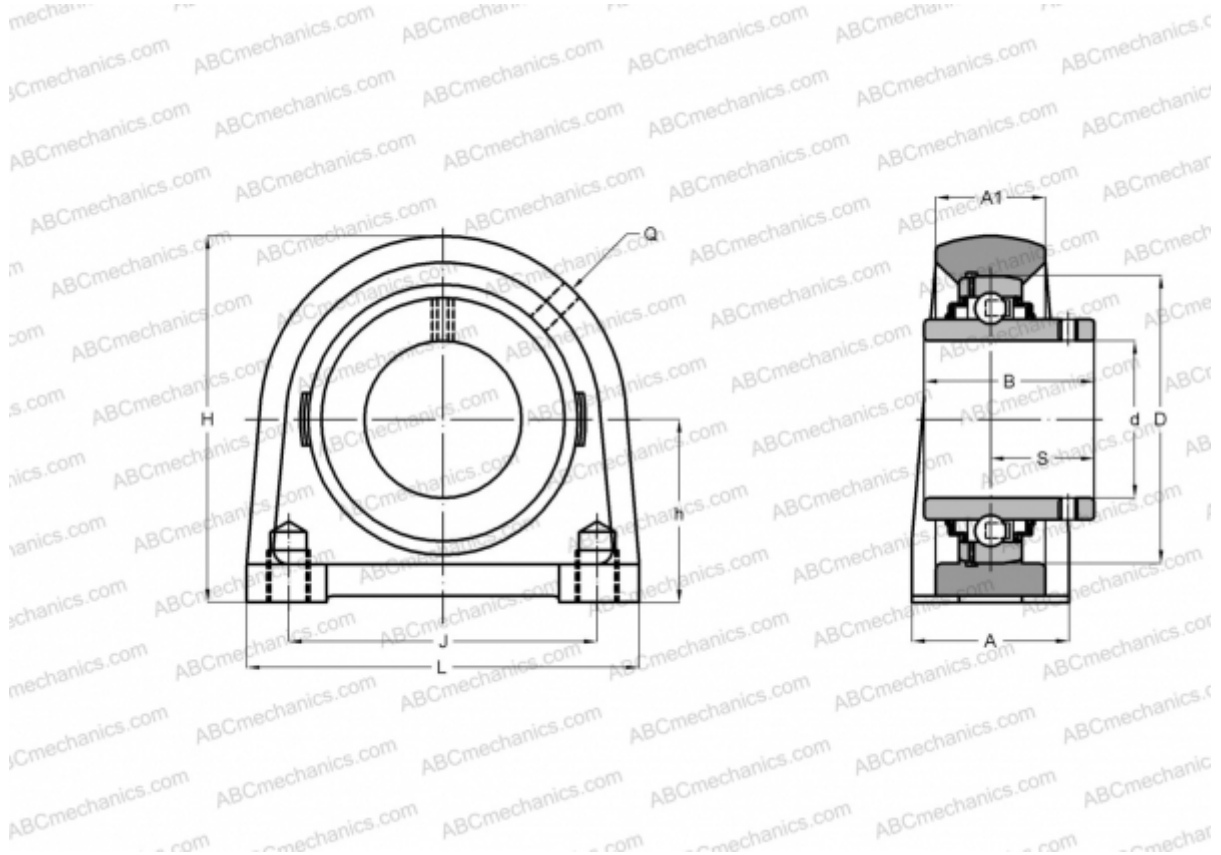

Technical specification

DIMENSIONS, MM

d	35,000
D	72,000
B	42,900
L	110,000
H	96,000
A	48,000
J	80,000
A1	30,500
S	25,400
h	47,600

WEIGHT, KG

1,400

Bearing	YAR 207-2F
Housing	SYFJ 507

MANUFACTURER

[SKF](#)

CALCULATION DATA

Basic dynamic load rating, C	25,500 kN
Basic static load rating, Co	15,300 kN
Fatigue load limit, Pu	0,655 kN
Limiting speed	5300 r/min