

SYFJ 45 TF SKF

Ball bearing units

TYPE: Housing units, Plummer block, Narrow cast iron housing, Radial insert ball bearing with grub screws in inner ring, Type SYF/SYFJ..TF (SKF)

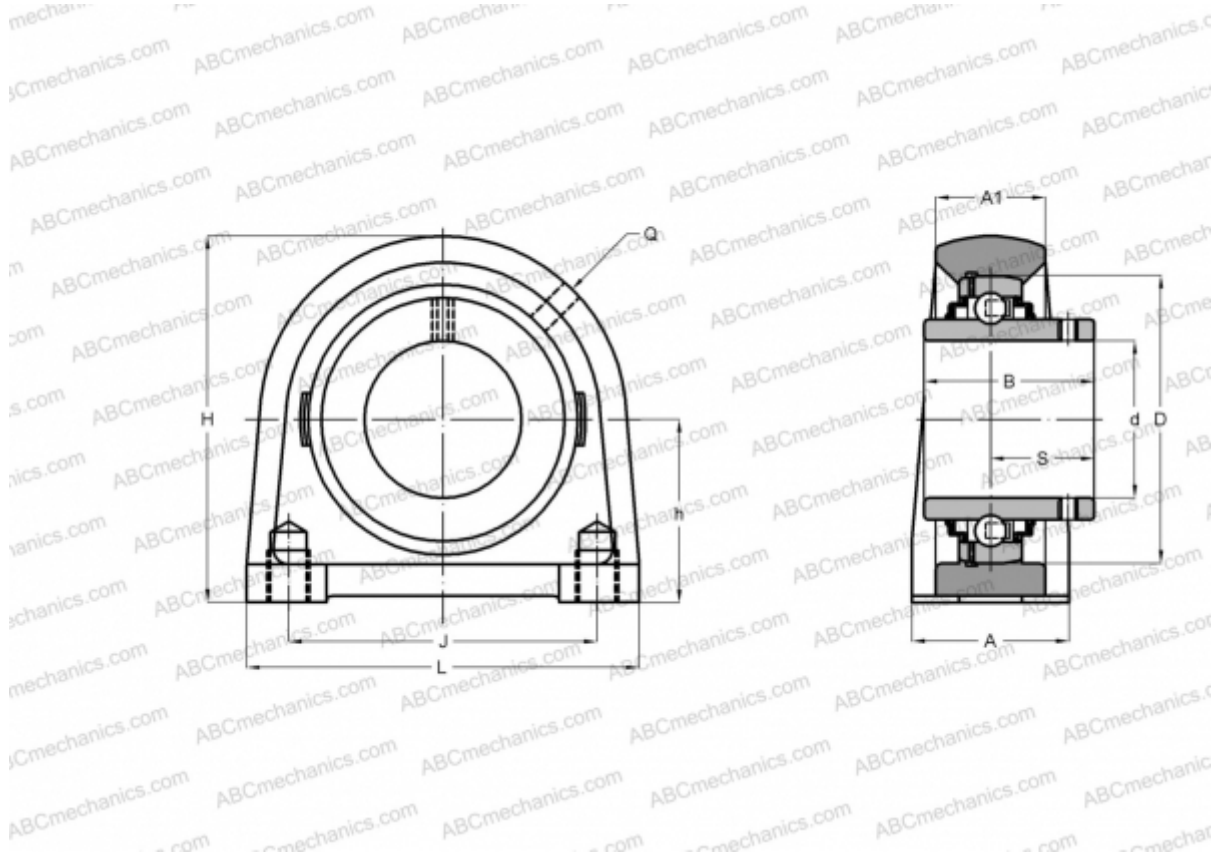

Technical specification

DIMENSIONS, MM

d	45,000
D	85,000
B	49,200
L	120,000
H	109,000
A	54,000
J	90,000
A1	33,500
S	30,200
h	54,200

WEIGHT, KG

1,850

Bearing	YAR 209-2F
Housing	SYFJ 509

MANUFACTURER

[SKF](#)

CALCULATION DATA

Basic dynamic load rating, C	33,200 kN
Basic static load rating, Co	21,600 kN
Fatigue load limit, Pu	0,915 kN
Limiting speed	4300 r/min