

SYFJ 50 TF SKF

Ball bearing units

TYPE: Housing units, Plummer block, Narrow cast iron housing, Radial insert ball bearing with grub screws in inner ring, Type SYF/SYFJ..TF (SKF)

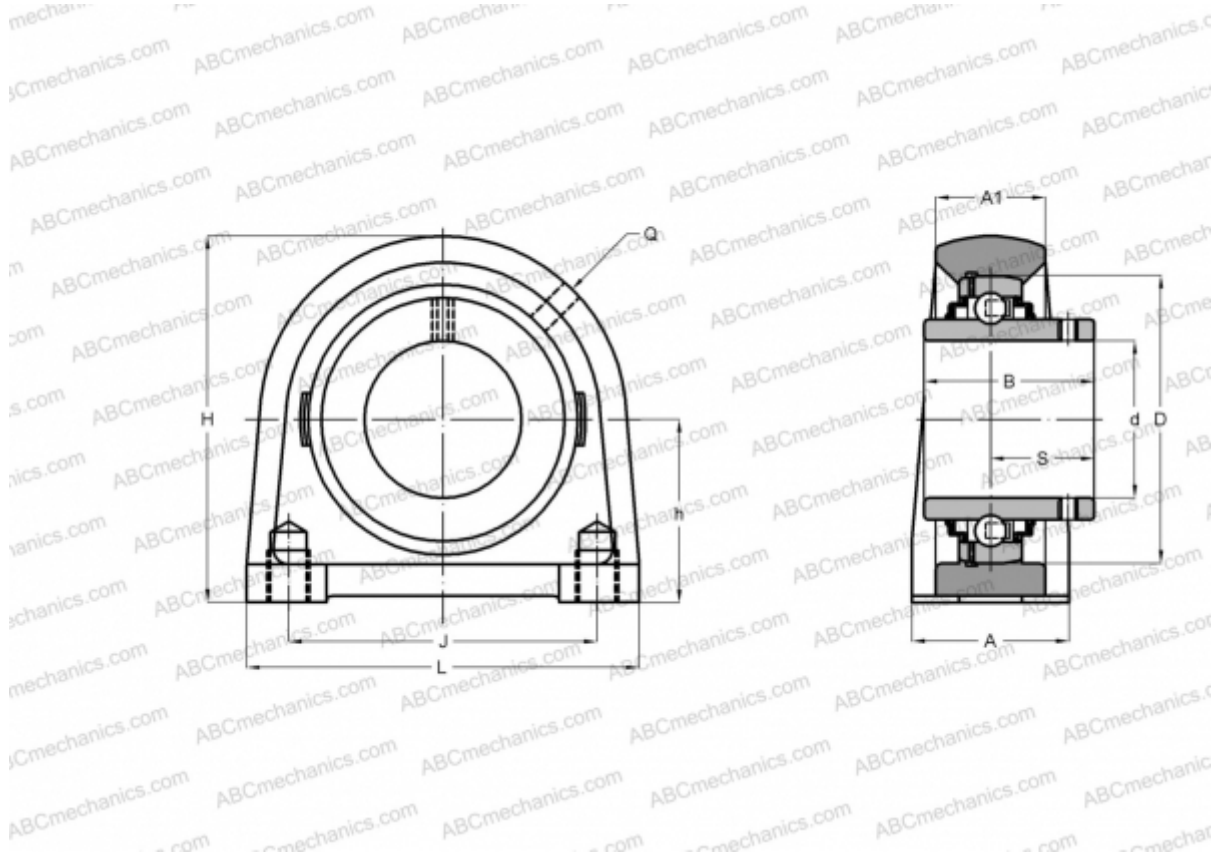

Technical specification

DIMENSIONS, MM

d	50,000
D	90,000
B	51,600
L	130,000
H	117,000
A	60,000
J	94,000
A1	35,500
S	32,600
h	57,200

WEIGHT, KG

2,300

Bearing	YAR 210-2F
Housing	SYFJ 510

MANUFACTURER

[SKF](#)

CALCULATION DATA

Basic dynamic load rating, C	35,100 kN
Basic static load rating, Co	23,200 kN
Fatigue load limit, Pu	0,980 kN
Limiting speed	4000 r/min