

P 17 TF SKF

Ball bearing units

TYPE: Housing units, Plummer block, Sheet steel housing, Radial insert ball bearing with grub screws in inner ring, Type P..TF (SKF)

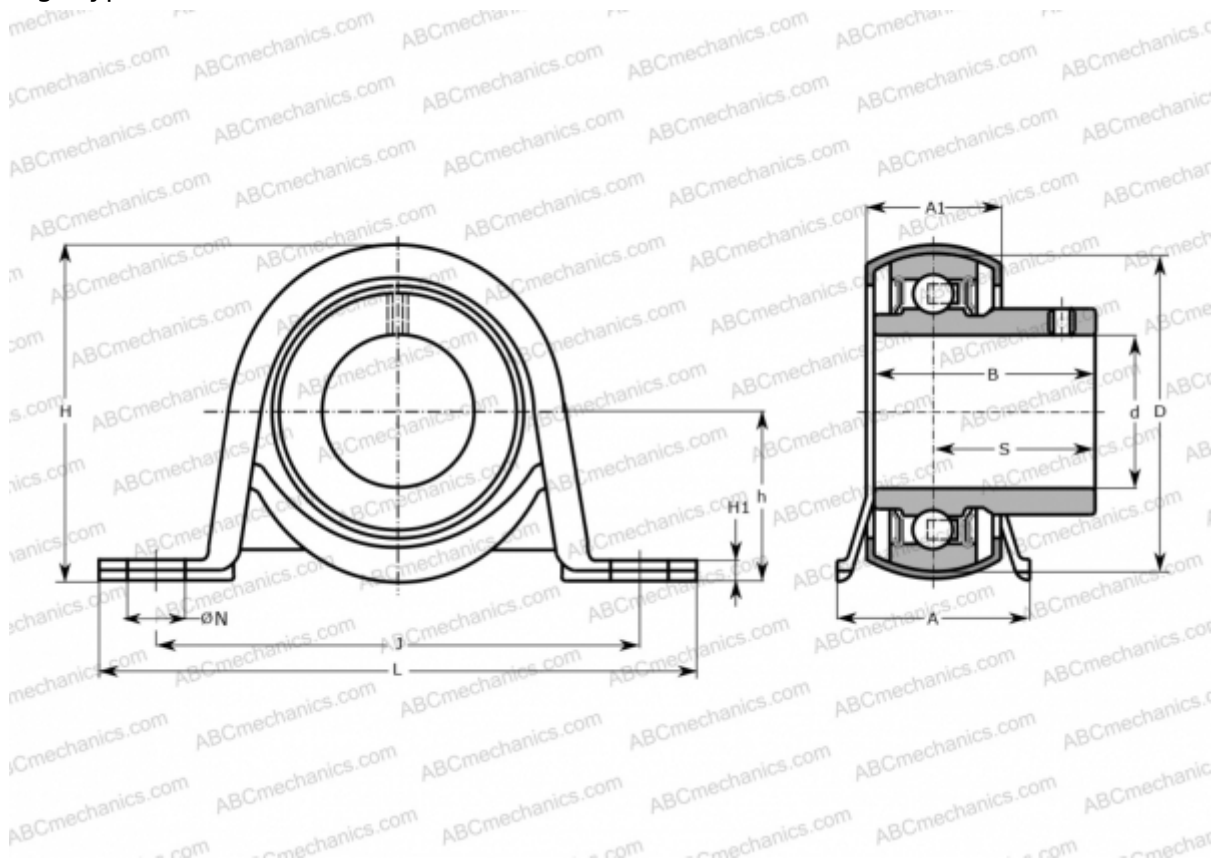

Technical specification

DIMENSIONS, MM

d	17,000
D	40,000
B	27,400
L	86,000
H	44,000
A	26,000
J	68,000
A1	18,000
H1	3,000
N	9,600
S	15,900
h	22,000

WEIGHT, KG 0,160

Bearing	YAR 203-2F
Housing	P 40

MANUFACTURER

[SKF](#)

CALCULATION DATA

Basic dynamic load rating, C	9,560 kN
Basic static load rating, Co	4,750 kN
Fatigue load limit, Pu	0,200 kN