

P 20 TR SKF

Ball bearing units

TYPE: Housing units, Plummer block, Sheet steel housing, Radial insert ball bearing with grub screws in inner ring, Type P..TR (SKF)

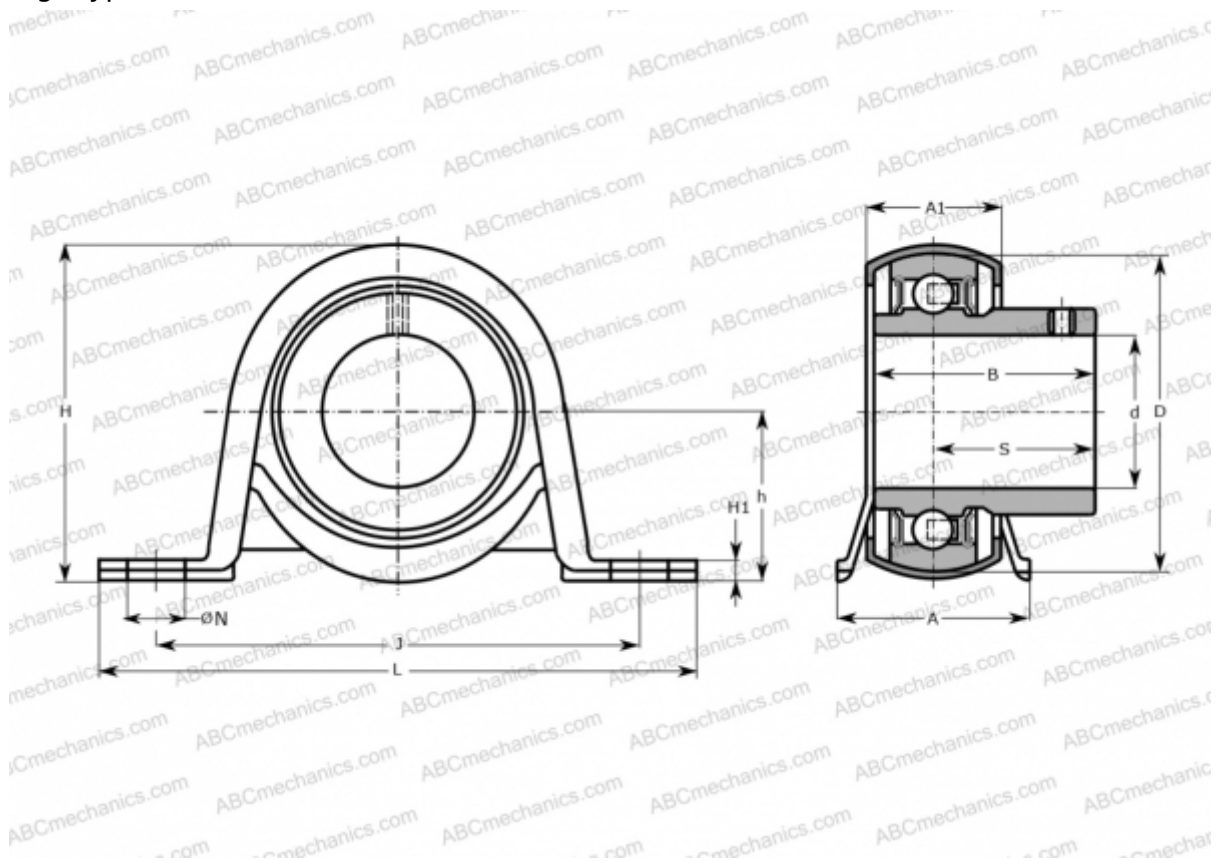

Technical specification

DIMENSIONS, MM

d	20,000
D	47,000
B	31,000
L	99,000
H	50,000
A	32,000
J	76,000
A1	21,000
H1	3,000
N	9,600
S	18,300
h	25,200

WEIGHT, KG 0,220

Bearing	YAR 204-2RF
Housing	P 47

MANUFACTURER

[SKF](#)

CALCULATION DATA

Basic dynamic load rating, C	12,700 kN
Basic static load rating, Co	6,550 kN
Fatigue load limit, Pu	0,280 kN