

P 40 TR SKF

Ball bearing units

TYPE: Housing units, Plummer block, Sheet steel housing, Radial insert ball bearing with grub screws in inner ring, Type P..TR (SKF)

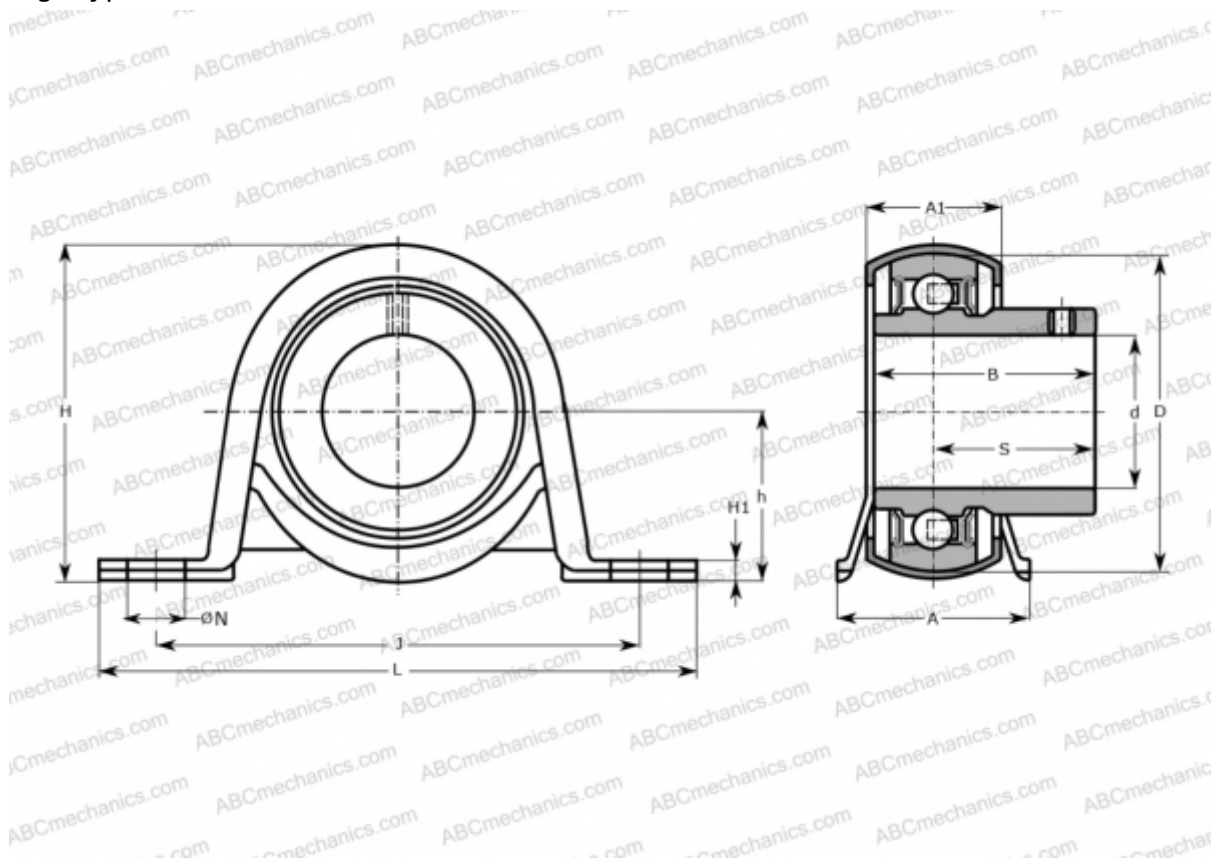

Technical specification

DIMENSIONS, MM

d	40,000
D	80,000
B	49,200
L	148,000
H	86,000
A	43,000
J	120,000
A1	29,000
H1	5,000
N	14,000
S	30,200
h	43,500

WEIGHT, KG 0,920

Bearing	YAR 208-2RF
Housing	P 80

MANUFACTURER

[SKF](#)

CALCULATION DATA

Basic dynamic load rating, C	30,700 kN
Basic static load rating, Co	19,000 kN
Fatigue load limit, Pu	0,800 kN