

P 45 RM SKF

Ball bearing units

TYPE: Housing units, Plummer block, Sheet steel housing, Radial insert ball bearing with grub screws in inner ring, Type P..RM (SKF)

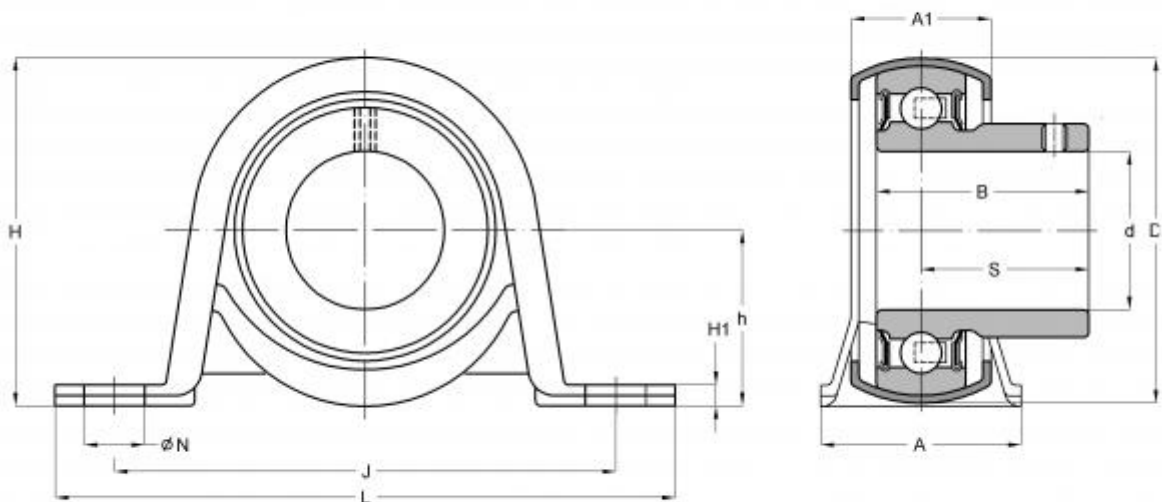

Technical specification

DIMENSIONS, MM

d	45,000
D	85,000
B	37,000
L	156,000
H	92,000
A	45,000
J	128,000
A1	31,000
H1	6,000
N	14,000
S	25,800
h	46,400

WEIGHT, KG 0,880

Bearing	YAT 209
Housing	P 85

MANUFACTURER

[SKF](#)

CALCULATION DATA

Basic dynamic load rating, C	33,200 kN
Basic static load rating, Co	21,600 kN
Fatigue load limit, Pu	0,915 kN