

## P 52 R-20 TF SKF

Ball bearing units

TYPE: Housing units, Plummer block, Sheet steel housing, Radial insert ball bearing with eccentric locking collar and rubber interliner, Type P..R..TF (SKF)

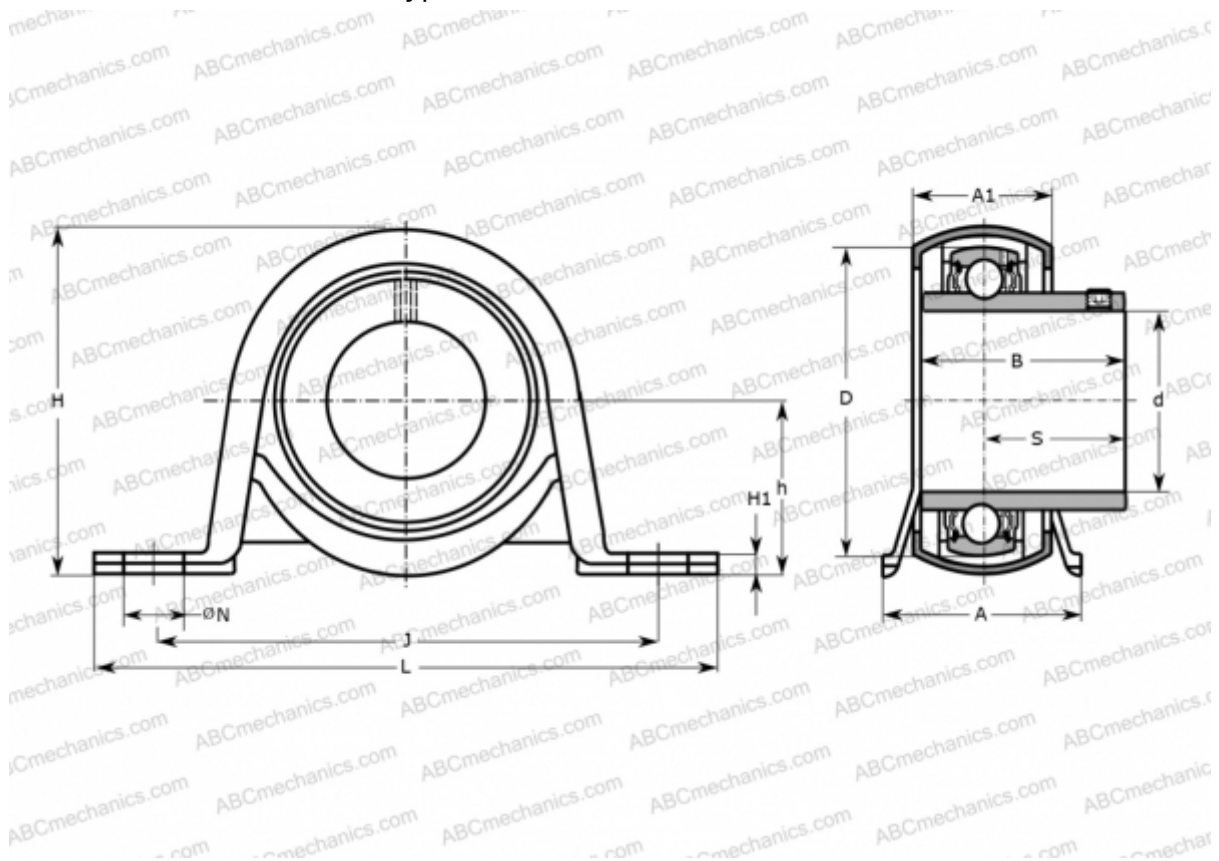

### Technical specification

#### DIMENSIONS, MM

d	20,000
D	47,000
B	31,000
L	108,000
H	56,000
A	32,000
J	86,000
A1	24,000
H1	3,200
N	11,200
S	18,300
h	28,300

**WEIGHT, KG** 0,260

Bearing	YAR 204-2F
Housing	P 52
Seal	RIS 204

#### MANUFACTURER

[SKF](#)

#### CALCULATION DATA

Basic dynamic load rating, C	12,700 kN
Basic static load rating, Co	6,550 kN
Fatigue load limit, Pu	0,280 kN