

P 62 R-25 RM SKF

Ball bearing units

TYPE: Housing units, Plummer block, Sheet steel housing, Radial insert ball bearing with eccentric locking collar and rubber interliner, Type P..R..RM (SKF)

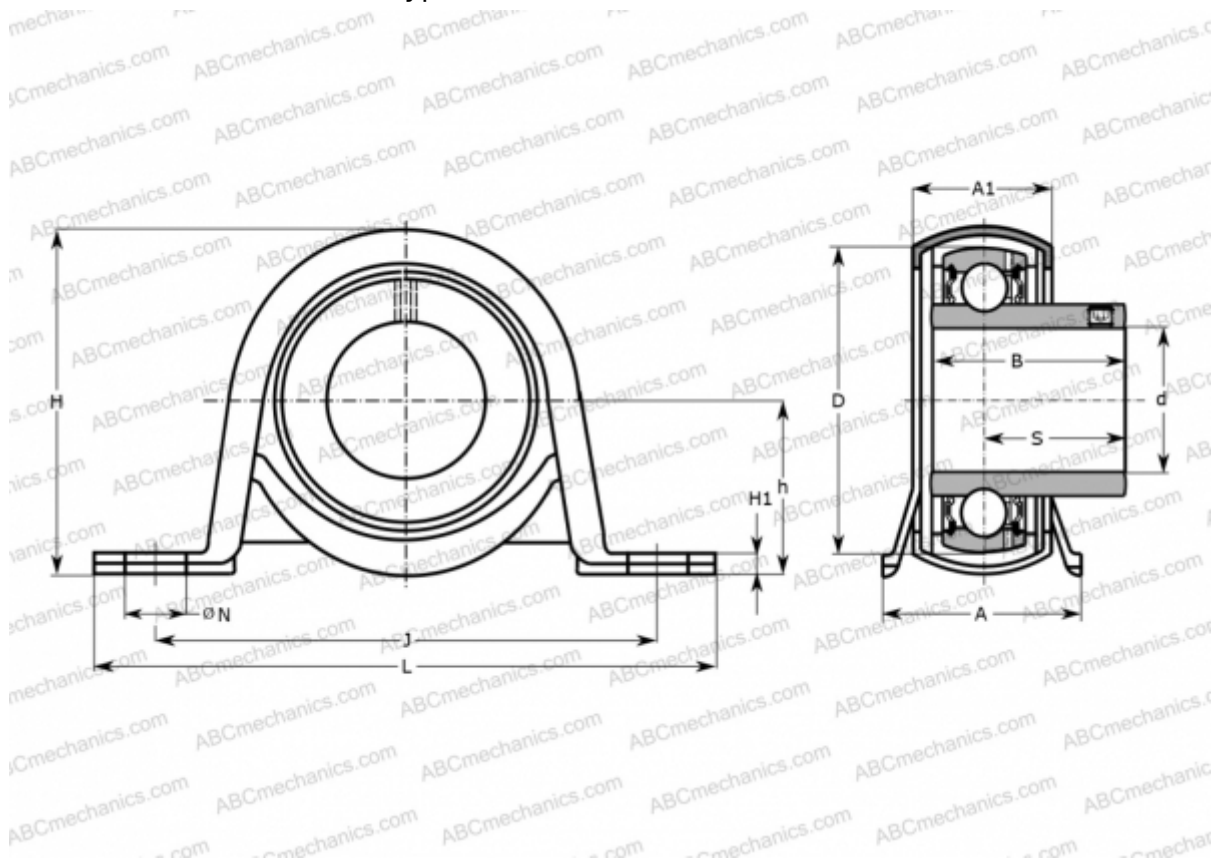

Technical specification

DIMENSIONS, MM

d	25,000
D	52,000
B	27,200
L	119,000
H	66,000
A	38,000
J	95,000
A1	25,000
H1	4,000
N	11,200
S	19,500
h	32,900

WEIGHT, KG 0,350

Bearing	YAT 205
Housing	P 62
Seal	RIS 205

MANUFACTURER

[SKF](#)

CALCULATION DATA

Basic dynamic load rating, C	14,000 kN
Basic static load rating, Co	7,800 kN
Fatigue load limit, Pu	0,335 kN