

P 1.1/4 TF SKF

Ball bearing units

TYPE: Housing units, Plummer block, Sheet steel housing, Radial insert ball bearing with grub screws in inner ring, Type P..TF (SKF), inch

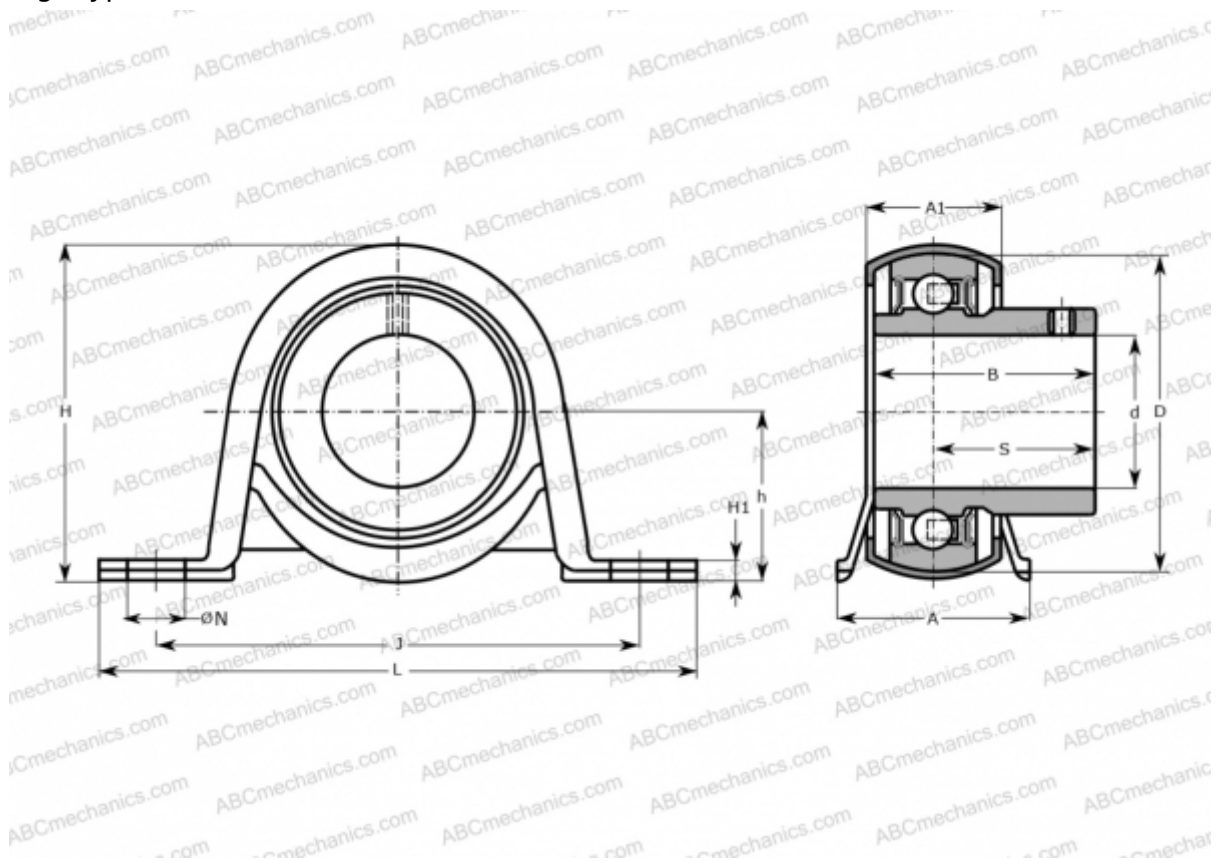

Technical specification

DIMENSIONS, MM

d	31,750
D	72,000
B	42,900
L	130,000
H	78,000
A	41,000
J	106,000
A1	27,000
H1	5,000
N	11,200
S	25,400
h	39,200

WEIGHT, KG 0,730

Bearing	YAR 207-104-
Housing	P 72

MANUFACTURER

[SKF](#)

CALCULATION DATA

Basic dynamic load rating, C	25,500 kN
Basic static load rating, Co	15,300 kN
Fatigue load limit, Pu	0,655 kN