

P 30 FM SKF

Ball bearing units

TYPE: Housing units, Plummer block, Sheet steel housing, Radial insert ball bearing with eccentric locking collar, Type P..FM (SKF)

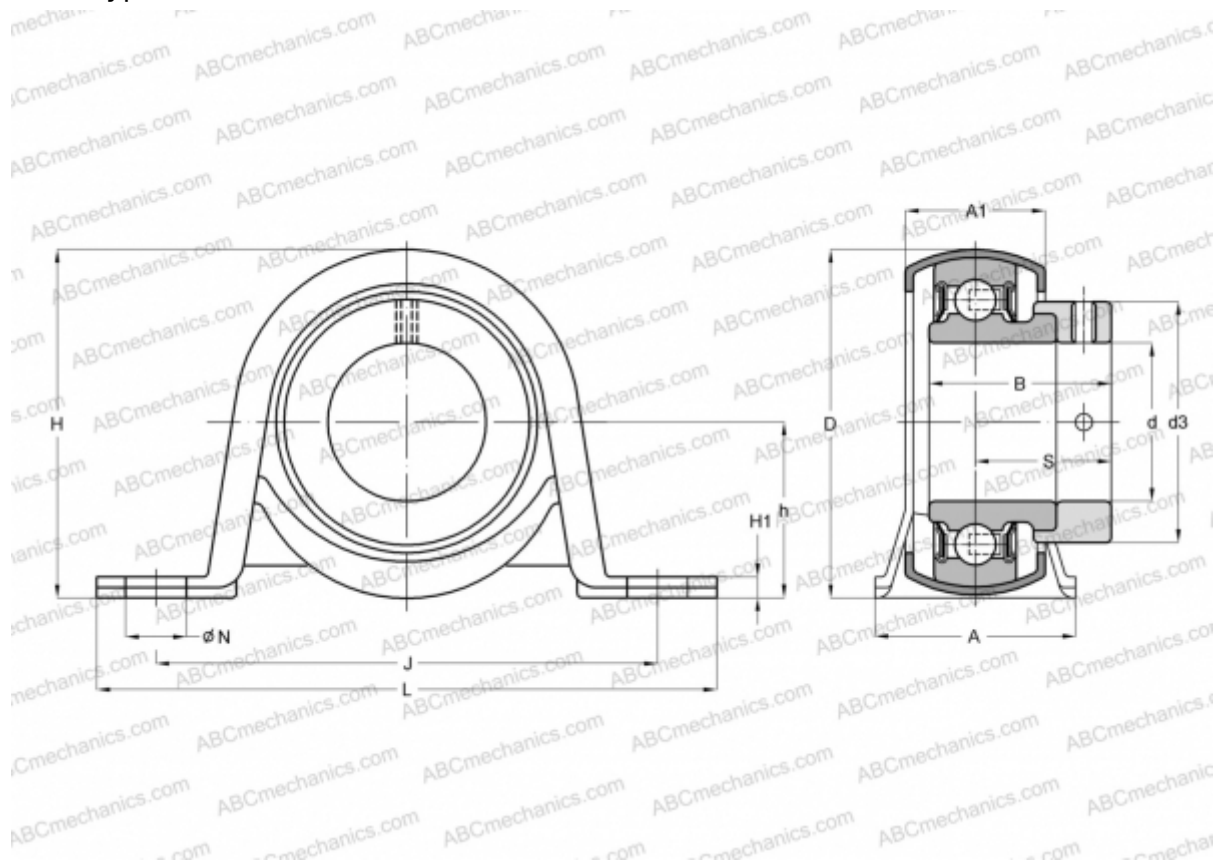

Technical specification

DIMENSIONS, MM

d	30,000
D	62,000
B	35,700
L	119,000
H	66,000
A	38,000
J	95,000
A1	25,000
H1	4,000
N	11,200
S	26,700
h	32,900

WEIGHT, KG 0,450

Bearing	YET 206
Housing	P 62

MANUFACTURER

[SKF](#)

CALCULATION DATA

Basic dynamic load rating, C	19,500 kN
Basic static load rating, Co	11,200 kN
Fatigue load limit, Pu	0,475 kN