

## P 20 WF SKF

Ball bearing units

TYPE: Housing units, Plummer block, Sheet steel housing, Radial insert ball bearing with eccentric locking collar, Type P..WF (SKF)

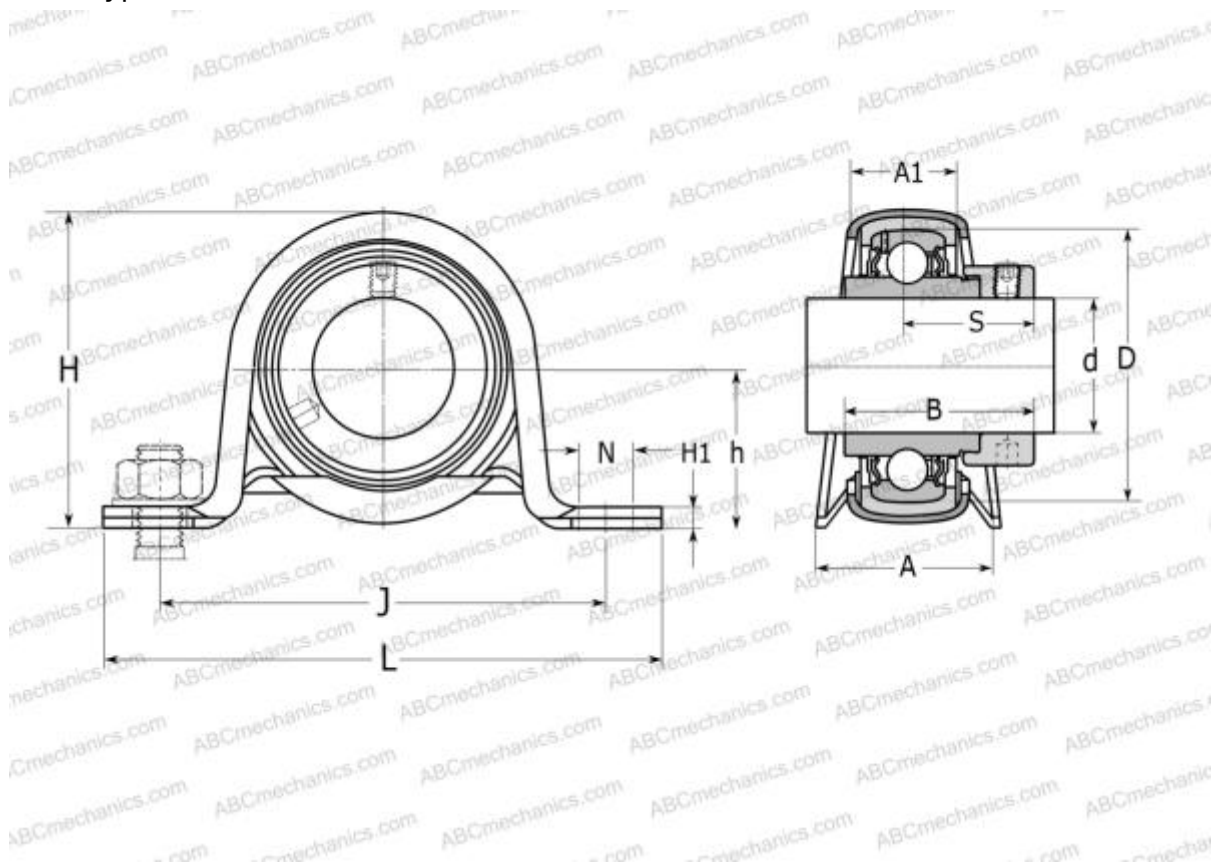

### Technical specification

#### DIMENSIONS, MM

d	20,000
D	20,000
B	43,700
L	99,000
H	50,000
A	32,000
J	76,000
A1	21,000
H1	3,000
N	9,600
S	26,600
h	25,200

**WEIGHT, KG** 0,270

Bearing	YEL 204-2F
Housing	P 47

#### MANUFACTURER

[SKF](https://www.skf.com)

#### CALCULATION DATA

Basic dynamic load rating, C	12,700 kN
Basic static load rating, Co	6,550 kN
Fatigue load limit, Pu	0,280 kN