

P 47 R-17 FM SKF

Ball bearing units

TYPE: Housing units, Plummer block, Sheet steel housing, Radial insert ball bearing with eccentric locking collar and rubber interliner, Type P..R..FM (SKF)

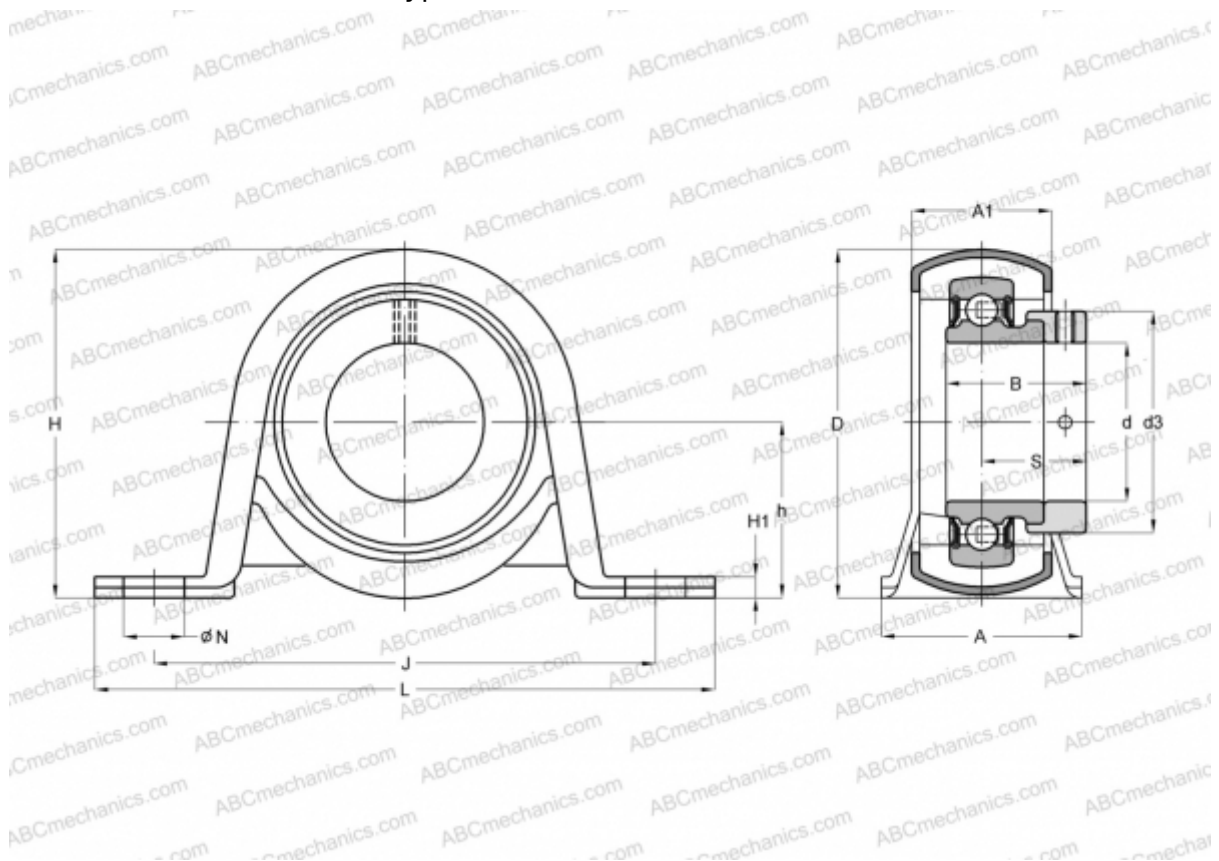

Technical specification

DIMENSIONS, MM

d	17,000
D	40,000
B	28,600
L	99,000
H	50,000
A	32,000
J	76,000
A1	21,000
H1	3,000
N	9,600
S	22,100
h	25,200

WEIGHT, KG 0,220

Bearing	YET 203
Housing	P 47
Seal	RIS 203

MANUFACTURER

[SKF](#)

CALCULATION DATA

Basic dynamic load rating, C	9,560 kN
Basic static load rating, Co	4,750 kN
Fatigue load limit, Pu	0,200 kN