

P 85 R-40 WF SKF

Ball bearing units

TYPE: Housing units, Plummer block, Sheet steel housing, Radial insert ball bearing with eccentric locking collar and rubber interliner, Type P..R..WF (SKF)

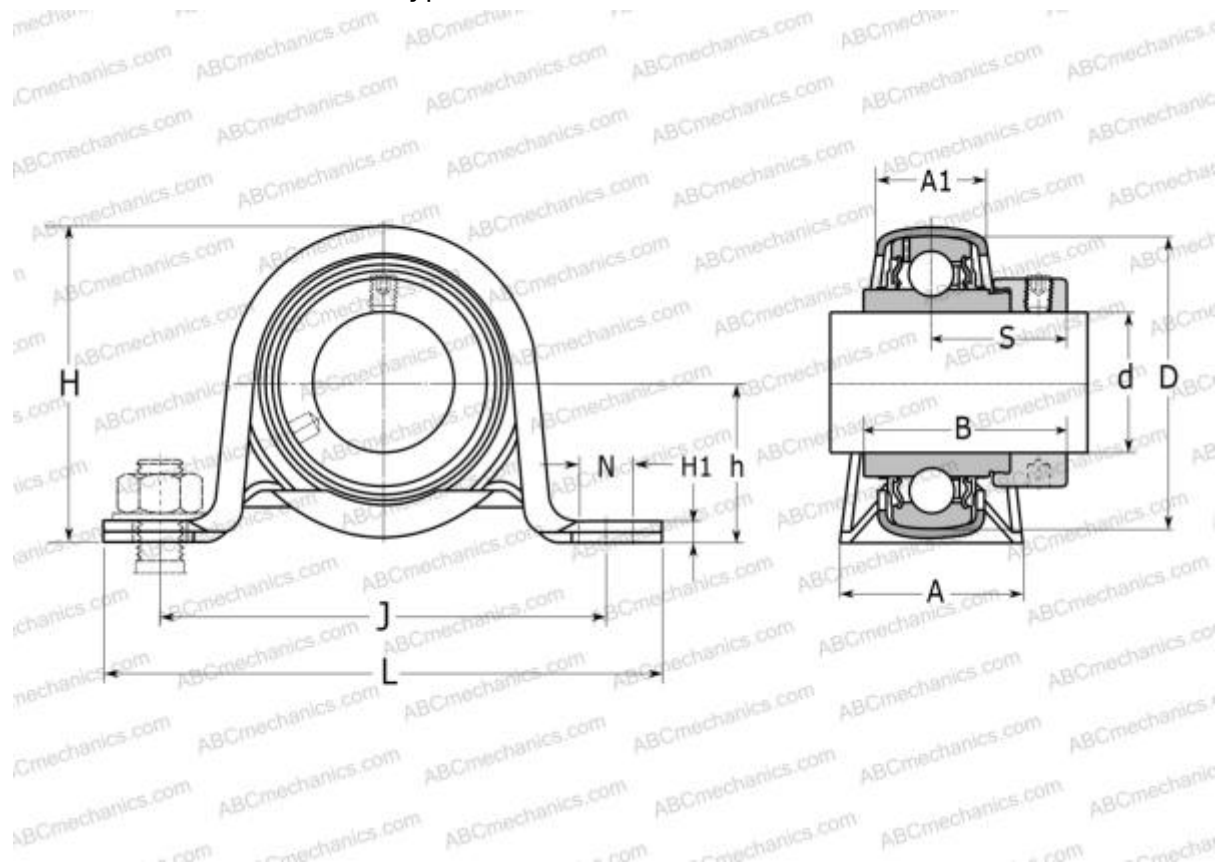

Technical specification

DIMENSIONS, MM

d	40,000
D	40,000
B	56,300
L	156,000
H	92,000
A	45,000
J	128,000
A1	31,000
H1	6,000
N	14,000
S	34,900
h	46,400

WEIGHT, KG 1,200

Bearing	YEL 208-2F
Housing	P 85
Seal	RIS 208 A

MANUFACTURER

[SKF](#)

CALCULATION DATA

Basic dynamic load rating, C	30,700 kN
Basic static load rating, Co	19,000 kN
Fatigue load limit, Pu	0,800 kN