

FYK 20 TR SKF

Ball bearing units

TYPE: Housing units, Four-bolt flanged housing units, Cast iron housing, Radial insert ball bearing with grub screws in inner ring, Type FYK..TR (SKF), composite

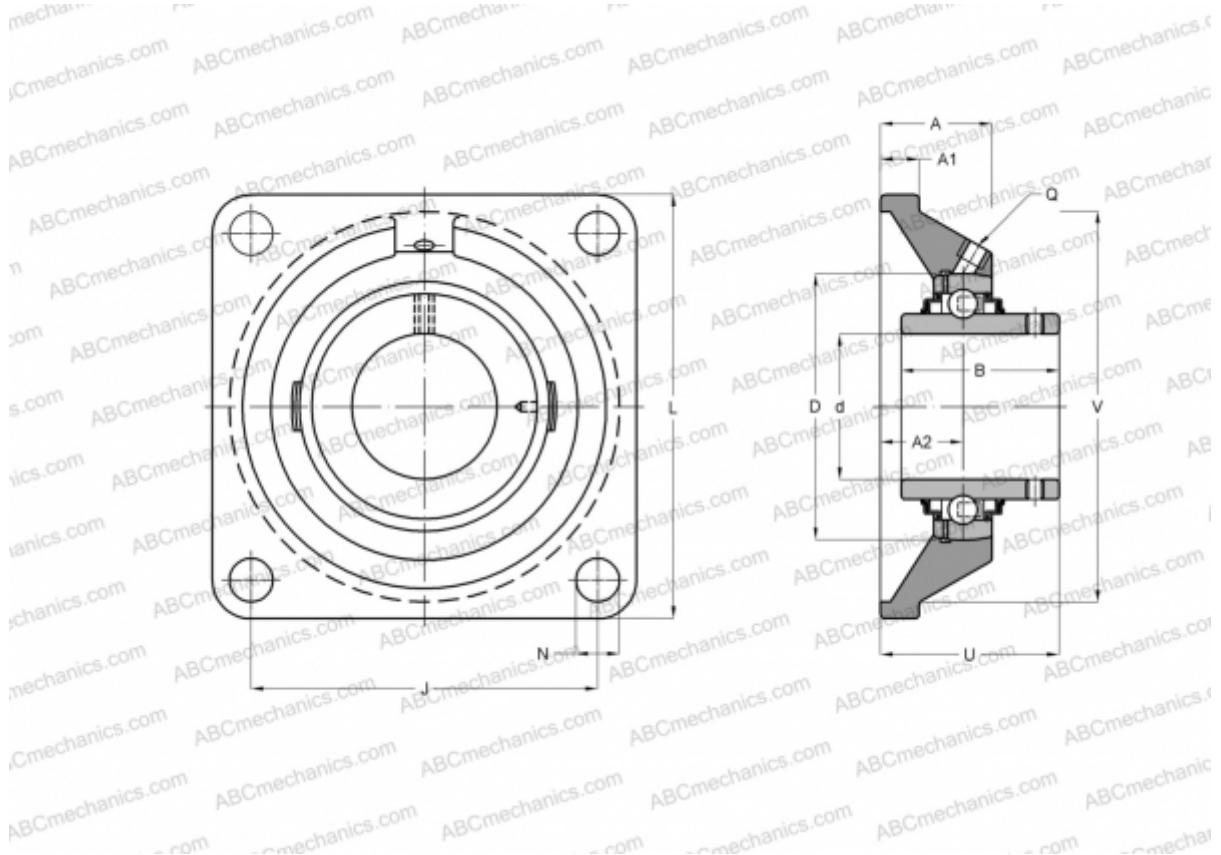

Technical specification

DIMENSIONS, MM

d	20,000
D	47,000
B	31,000
L	86,000
A	30,000
J	63,500
A1	15,000
A2	19,000
N	12,000
U	37,300
V	68,300

WEIGHT, KG 0,260

Bearing YAR 204-2RF

Housing	FYK 504
Protective cover	ECY 204

MANUFACTURER

[SKF](#)

CALCULATION DATA

Basic dynamic load rating, C	12,700 kN
Basic static load rating, Co	6,550 kN
Fatigue load limit, Pu	0,280 kN
Limiting speed	5000 r/min