

FYK 40 TR SKF

Ball bearing units

TYPE: Housing units, Four-bolt flanged housing units, Cast iron housing, Radial insert ball bearing with grub screws in inner ring, Type FYK..TR (SKF), composite

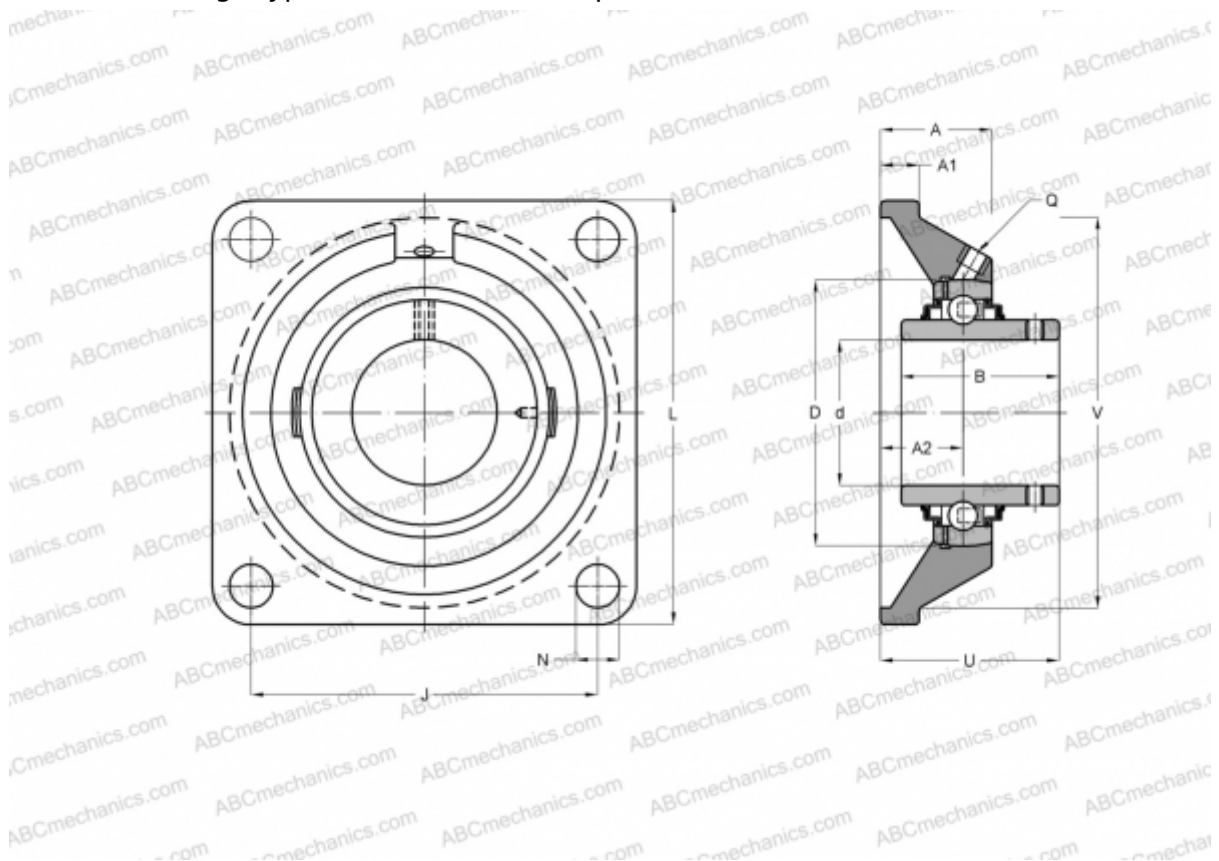

Technical specification

DIMENSIONS, MM

d	40,000
D	80,000
B	49,200
L	130,000
A	39,000
J	101,500
A1	17,000
A2	24,000
N	14,500
U	54,200
V	115,900

WEIGHT, KG 0,870

Bearing YAR 208-2RF

Housing	FYK 508
Protective cover	ECY 208

MANUFACTURER

[SKF](#)

CALCULATION DATA

Basic dynamic load rating, C	30,700 kN
Basic static load rating, Co	19,000 kN
Fatigue load limit, Pu	0,800 kN
Limiting speed	2800 r/min