

## FYTBK 30 TR SKF

Ball bearing units

TYPE: Housing units, Two-bolt flanged housing units, Cast iron housing, Radial insert ball bearing with grub screws in inner ring, Type FYTBK..TR (SKF), composite

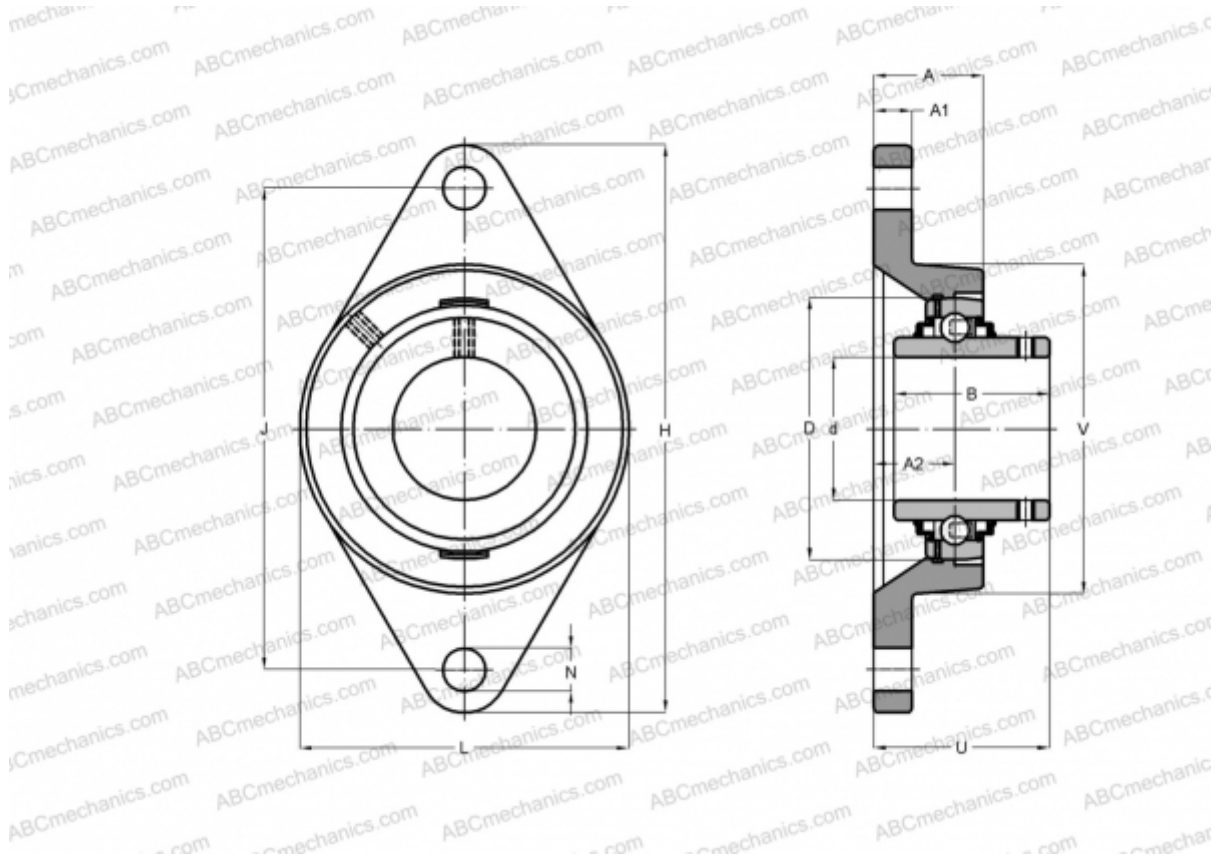

### Technical specification

#### DIMENSIONS, MM

d	30,000
D	62,000
B	38,100
L	83,000
H	142,500
A	33,000
J	116,500
A1	15,000
A2	20,000
N	12,000
U	42,200
V	76,200

**WEIGHT, KG** 0,440

Bearing	YAR 206-2RF
Housing	FYTBK 506
Protective cover	ECY 206

#### MANUFACTURER

[SKF](#)

#### CALCULATION DATA

Basic dynamic load rating, C	19,500 kN
Basic static load rating, Co	11,200 kN
Fatigue load limit, Pu	0,475 kN
Limiting speed	3800 r/min