

## FYJ 20 TF SKF

Ball bearing units

TYPE: Housing units, Four-bolt flanged housing units, Cast iron housing, Radial insert ball bearing with grub screws in inner ring, Type FY/FYJ..TF (SKF)

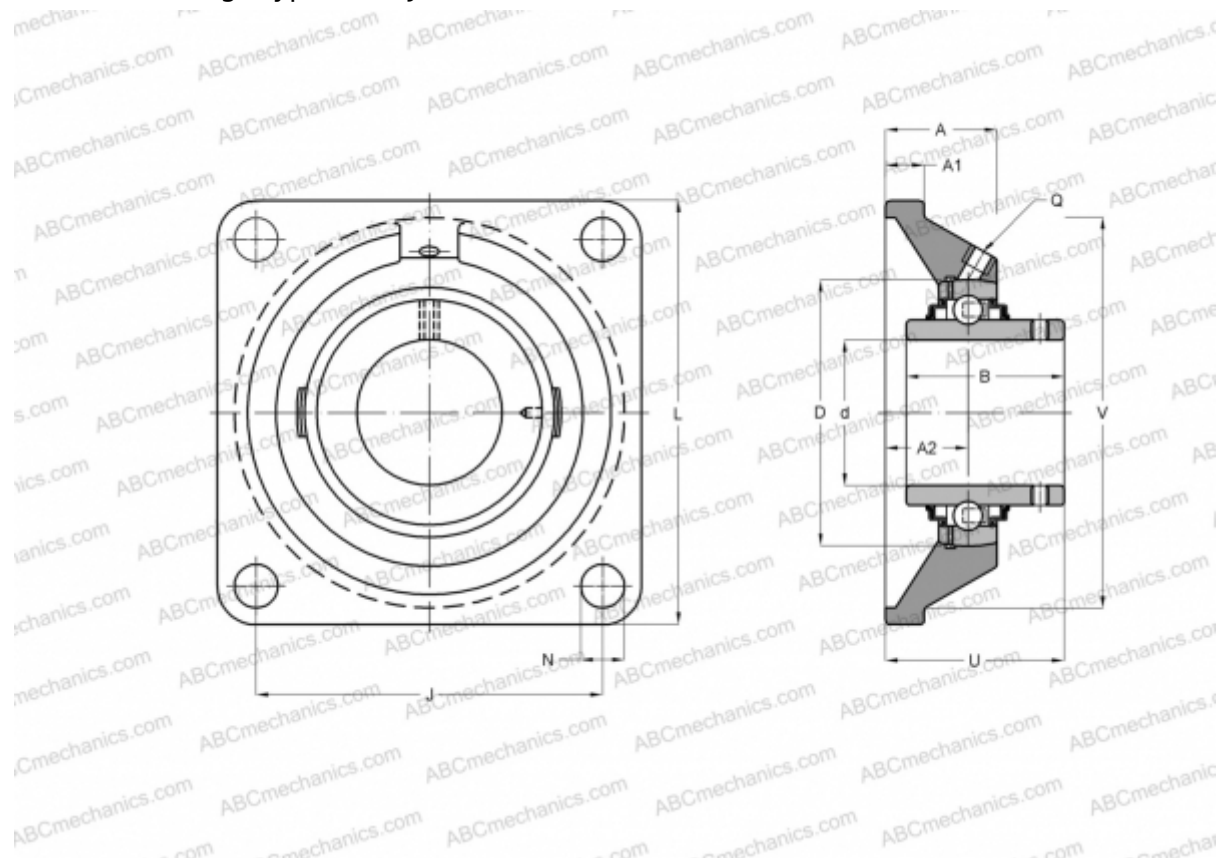

### Technical specification

#### DIMENSIONS, MM

d	20,000
D	20,000
B	31,000
L	86,000
A	25,500
J	64,000
A1	12,000
N	12,000
U	33,300
V	68,300

**WEIGHT, KG** 0,650

Bearing	YAR 204-2F
Housing	FYJ 504

#### MANUFACTURER

[SKF](#)

#### CALCULATION DATA

Basic dynamic load rating, C	12,700 kN
Basic static load rating, Co	6,550 kN
Fatigue load limit, Pu	0,280 kN
Limiting speed	8500 r/min