

FYJ 30 TF SKF

Ball bearing units

TYPE: Housing units, Four-bolt flanged housing units, Cast iron housing, Radial insert ball bearing with grub screws in inner ring, Type FY/FYJ..TF (SKF)

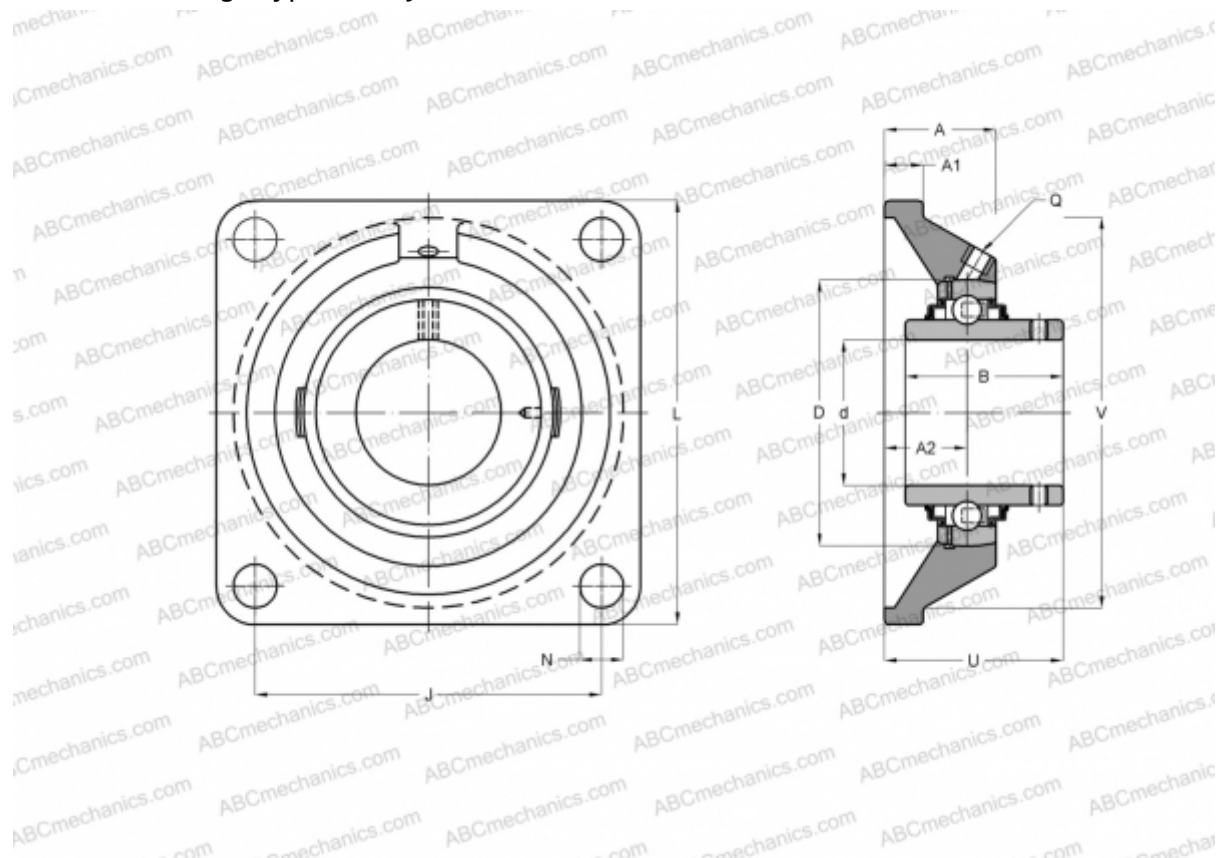

Technical specification

DIMENSIONS, MM

d	30,000
D	30,000
B	38,100
L	108,000
A	31,000
J	83,000
A1	14,000
N	12,000
U	40,200
V	93,700

WEIGHT, KG

1,200

Bearing	YAR 206-2F
Housing	FYJ 506

MANUFACTURER

[SKF](#)

CALCULATION DATA

Basic dynamic load rating, C	19,500 kN
Basic static load rating, Co	11,200 kN
Fatigue load limit, Pu	0,475 kN
Limiting speed	6300 r/min