

FYJ 35 TF SKF

Ball bearing units

TYPE: Housing units, Four-bolt flanged housing units, Cast iron housing, Radial insert ball bearing with grub screws in inner ring, Type FY/FYJ..TF (SKF)

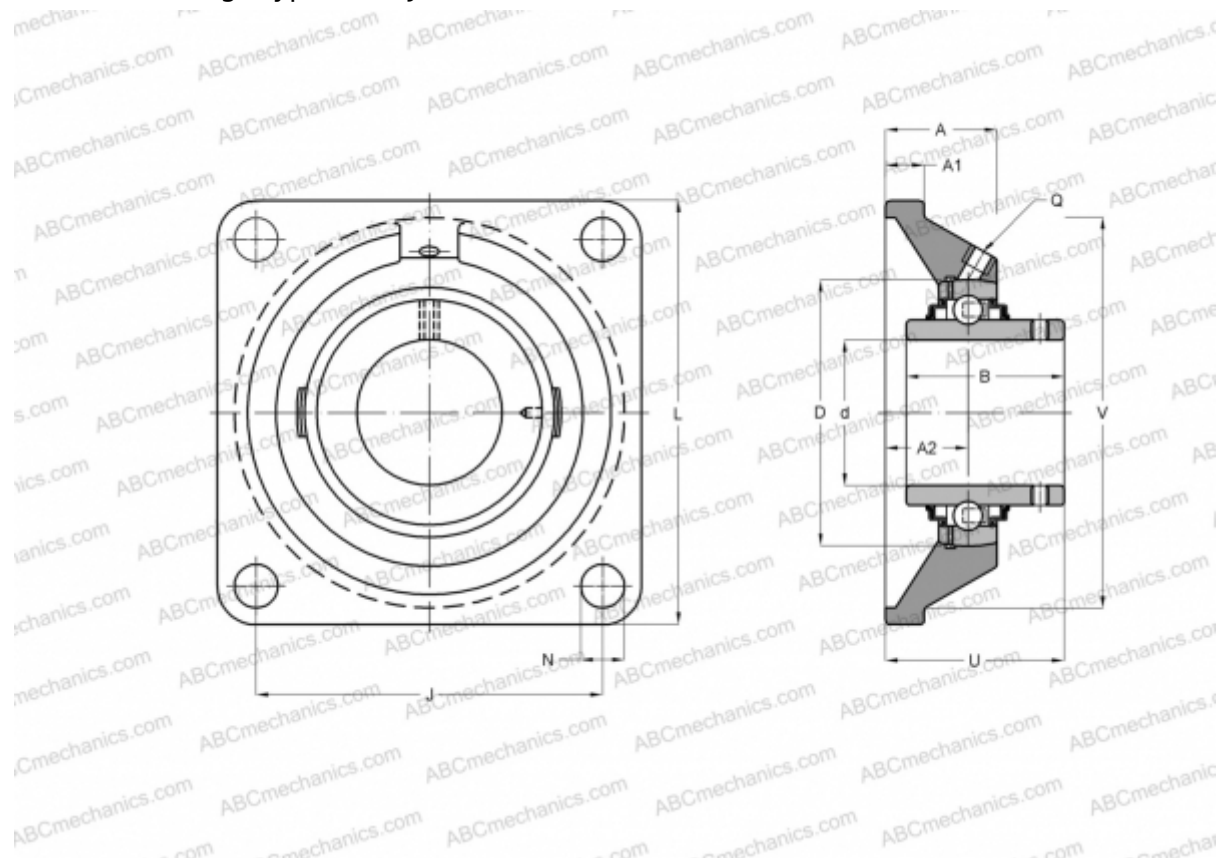

Technical specification

DIMENSIONS, MM

d	35,000
D	35,000
B	42,900
L	118,000
A	34,000
J	92,000
A1	16,000
N	14,000
U	44,400
V	106,400

WEIGHT, KG

1,500

Bearing	YAR 207-2F
Housing	FYJ 507

MANUFACTURER

[SKF](#)

CALCULATION DATA

Basic dynamic load rating, C	25,500 kN
Basic static load rating, Co	15,300 kN
Fatigue load limit, Pu	0,655 kN
Limiting speed	5300 r/min