

FYJ 40 TF SKF

Ball bearing units

TYPE: Housing units, Four-bolt flanged housing units, Cast iron housing, Radial insert ball bearing with grub screws in inner ring, Type FY/FYJ..TF (SKF)

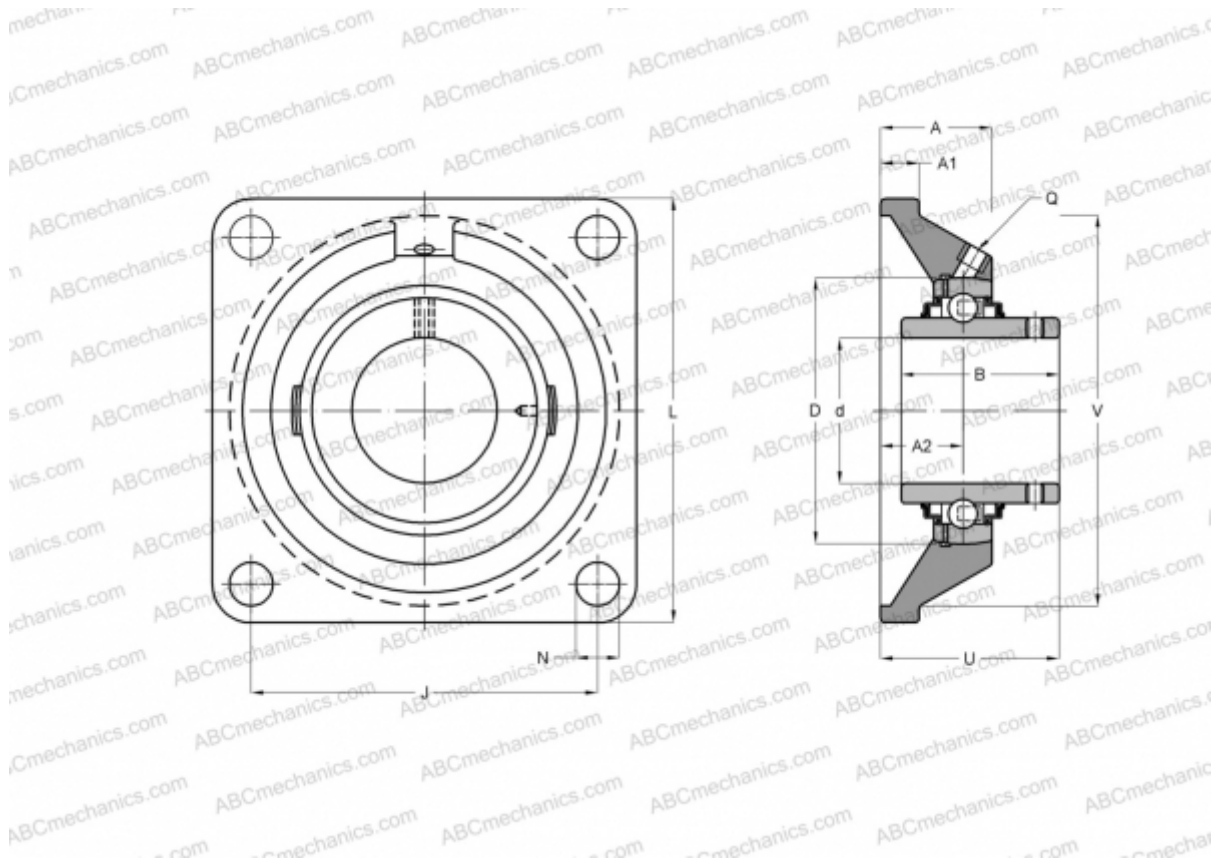

Technical specification

DIMENSIONS, MM

d	40,000
D	40,000
B	49,200
L	130,000
A	36,000
J	102,000
A1	16,000
N	16,000
U	51,200
V	115,900

WEIGHT, KG

1,800

Bearing	YAR 208-2F
Housing	FYJ 508

MANUFACTURER

[SKF](#)

CALCULATION DATA

Basic dynamic load rating, C	30,700 kN
Basic static load rating, Co	19,000 kN
Fatigue load limit, Pu	0,800 kN
Limiting speed	4800 r/min