

FY 50 TF SKF

Ball bearing units

TYPE: Housing units, Four-bolt flanged housing units, Cast iron housing, Radial insert ball bearing with grub screws in inner ring, Type FY/FYJ..TF (SKF)

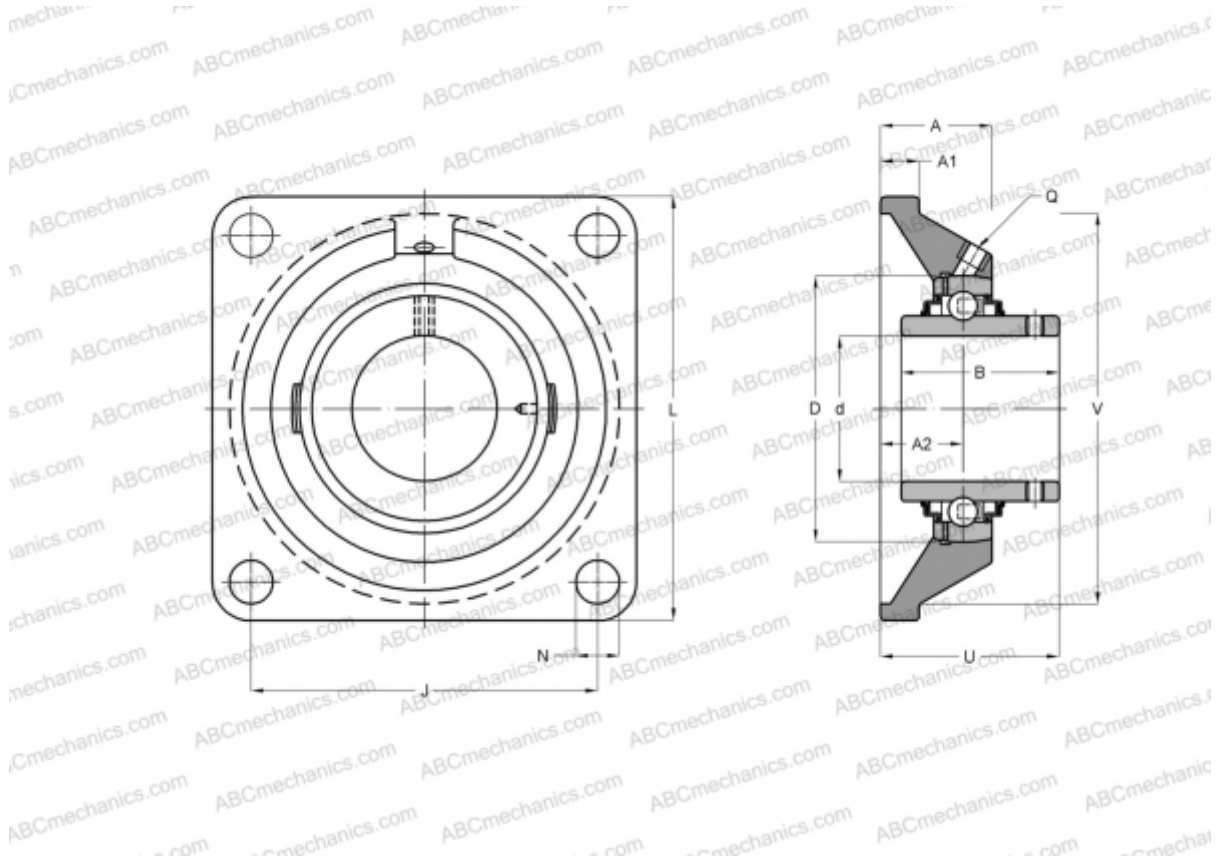

Technical specification

DIMENSIONS, MM

d	50,000
D	50,000
B	51,600
L	143,000
A	43,000
J	111,000
A1	15,000
N	18,000
U	60,600
V	125,400

WEIGHT, KG

2,500

Bearing	YAR 210-2F
Housing	FY 510 M

Protective cover

ECY 210

MANUFACTURER

[SKF](#)

CALCULATION DATA

Basic dynamic load rating, C	35,100 kN
Basic static load rating, Co	23,200 kN
Fatigue load limit, Pu	0,980 kN
Limiting speed	4000 r/min