

## FYJ 60 TF SKF

Ball bearing units

TYPE: Housing units, Four-bolt flanged housing units, Cast iron housing, Radial insert ball bearing with grub screws in inner ring, Type FY/FYJ..TF (SKF)

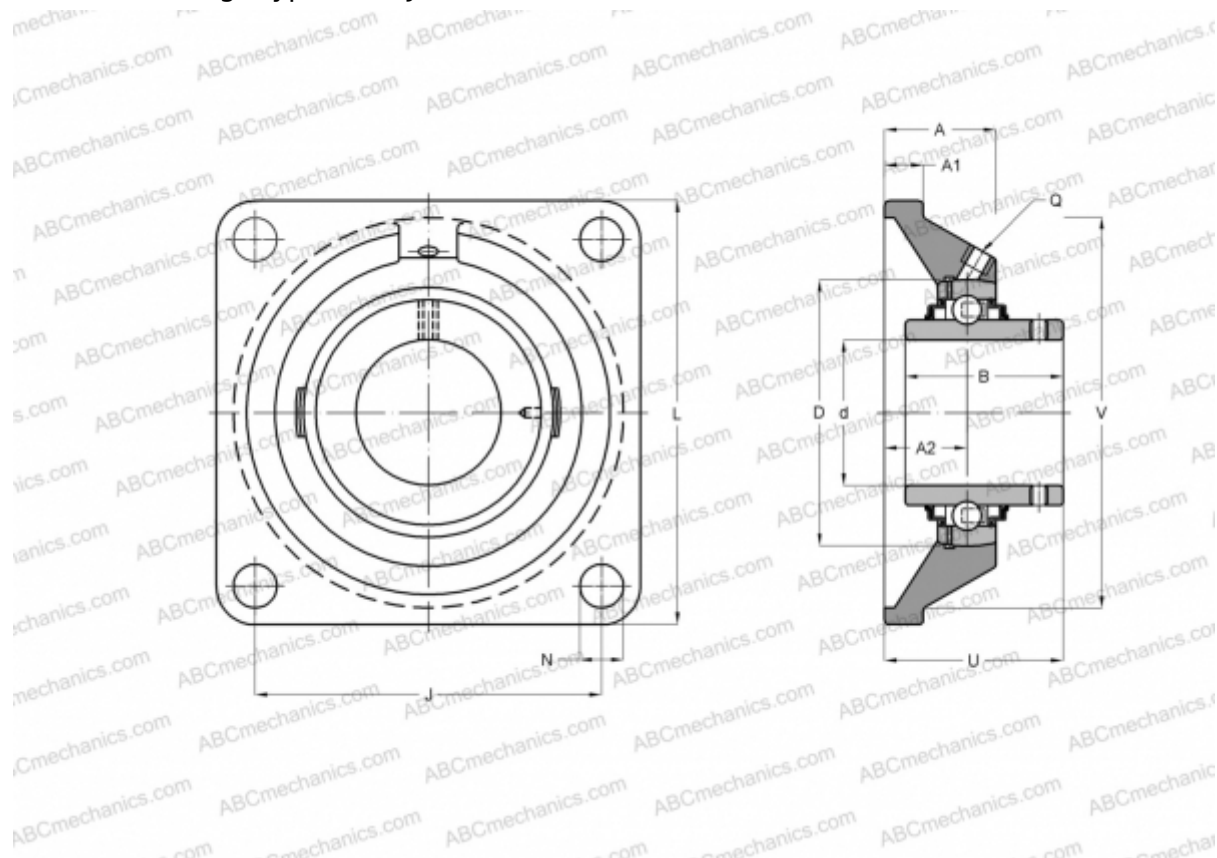

### Technical specification

#### DIMENSIONS, MM

d	60,000
D	60,000
B	65,100
L	175,000
A	48,000
J	143,000
A1	20,000
N	19,000
U	68,700
V	161,900

**WEIGHT, KG** 4,500

Bearing	YAR 212-2F
Housing	FYJ 512

#### MANUFACTURER

[SKF](#)

#### CALCULATION DATA

Basic dynamic load rating, C	52,700 kN
Basic static load rating, Co	36,000 kN
Fatigue load limit, Pu	1,530 kN
Limiting speed	3400 r/min