

FY 65 TF SKF

Ball bearing units

TYPE: Housing units, Four-bolt flanged housing units, Cast iron housing, Radial insert ball bearing with grub screws in inner ring, Type FY/FYJ..TF (SKF)

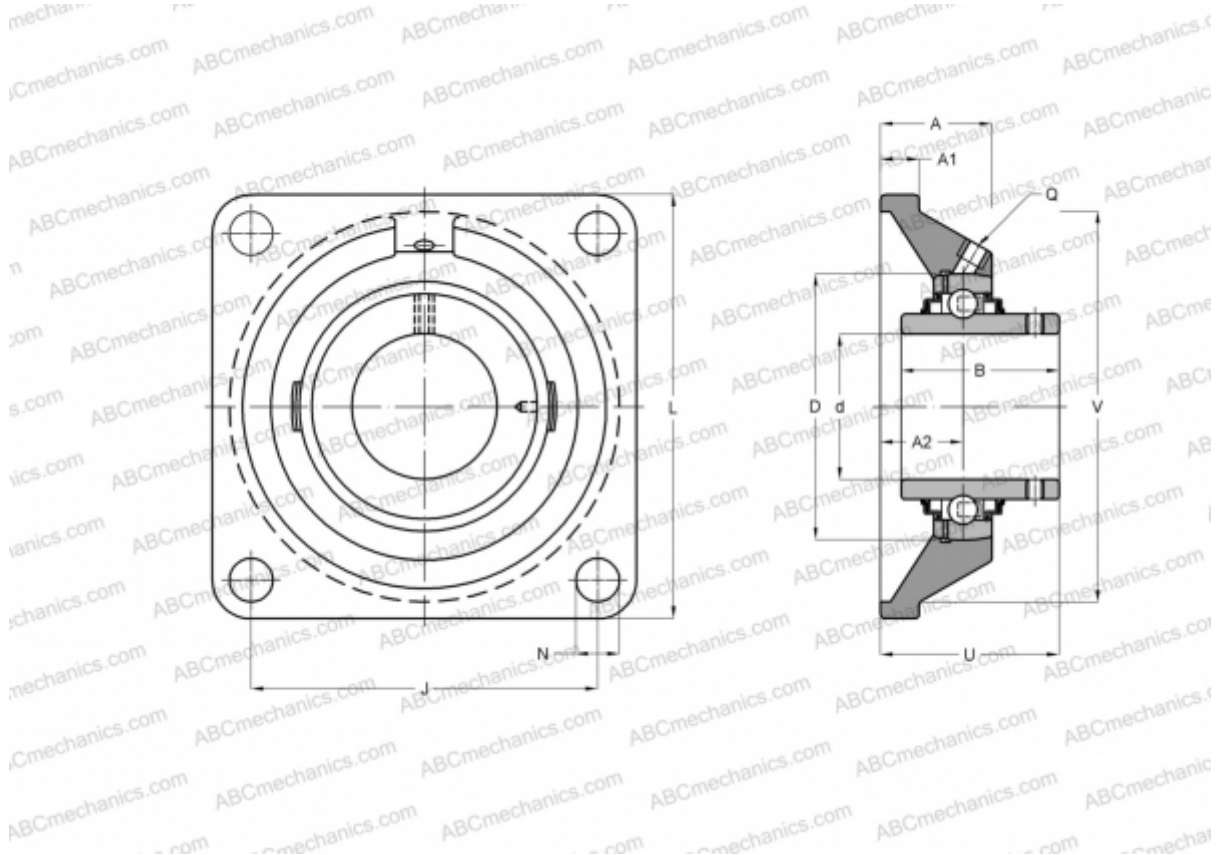

Technical specification

DIMENSIONS, MM

d	65,000
D	65,000
B	68,300
L	187,000
A	52,500
J	149,500
A1	17,000
N	18,000
U	76,900
V	161,900

WEIGHT, KG

5,300

Bearing	YAR 213-2F
Housing	FY 513 M

Protective cover

ECY 213

MANUFACTURER

[SKF](#)

CALCULATION DATA

Basic dynamic load rating, C	57,200 kN
Basic static load rating, Co	40,000 kN
Fatigue load limit, Pu	1,700 kN
Limiting speed	3000 r/min