

## FYJ 65 TF SKF

Ball bearing units

TYPE: Housing units, Four-bolt flanged housing units, Cast iron housing, Radial insert ball bearing with grub screws in inner ring, Type FY/FYJ..TF (SKF)

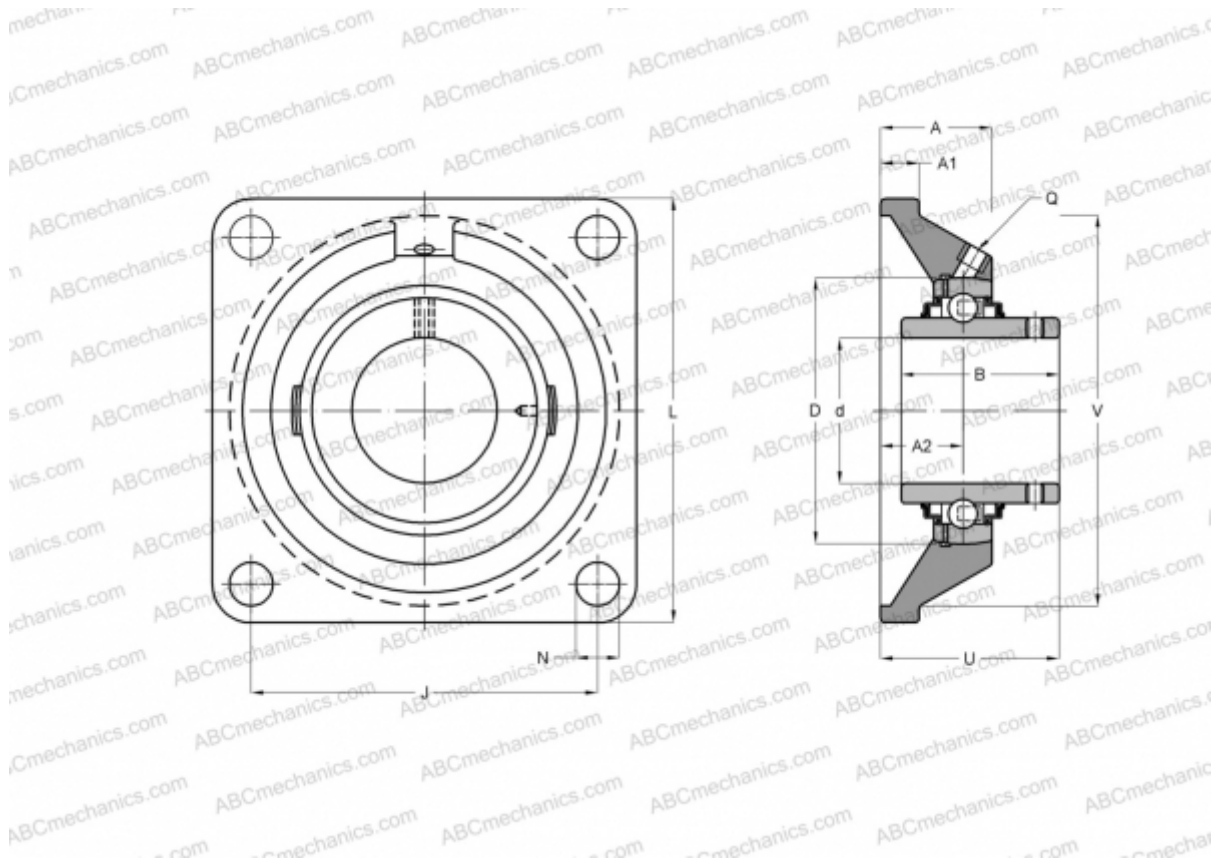

### Technical specification

#### DIMENSIONS, MM

d	65,000
D	65,000
B	68,300
L	187,000
A	50,000
J	149,000
A1	20,000
N	19,000
U	72,900
V	161,900

#### WEIGHT, KG

5,800

Bearing	YAR 213-2F
Housing	FYJ 513

#### MANUFACTURER

[SKF](#)

#### CALCULATION DATA

Basic dynamic load rating, C	57,200 kN
Basic static load rating, Co	40,000 kN
Fatigue load limit, Pu	1,700 kN
Limiting speed	3000 r/min