

FYJ 70 TF SKF

Ball bearing units

TYPE: Housing units, Four-bolt flanged housing units, Cast iron housing, Radial insert ball bearing with grub screws in inner ring, Type FY/FYJ..TF (SKF)

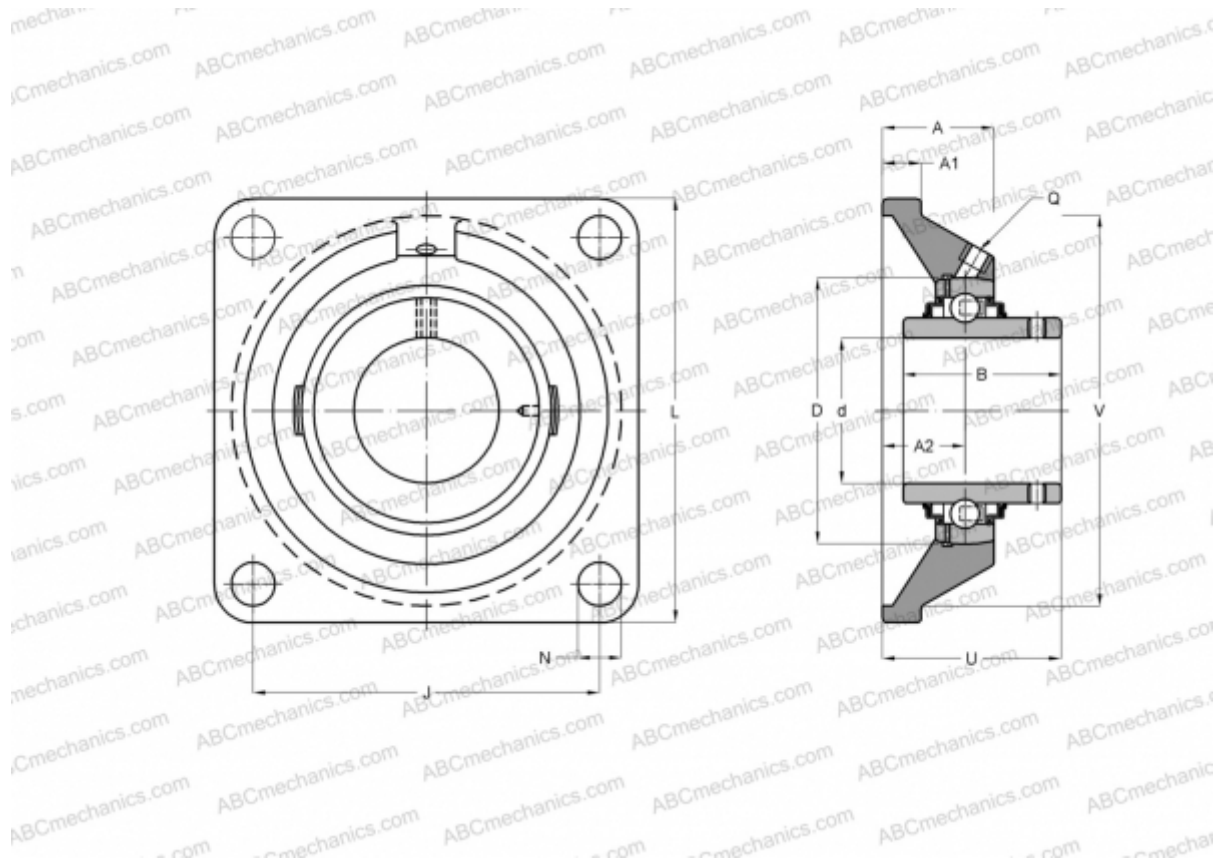

Technical specification

DIMENSIONS, MM

d	70,000
D	70,000
B	69,900
L	193,000
A	50,300
J	152,000
A1	21,300
N	19,000
U	70,700
V	161,900

WEIGHT, KG

6,000

Bearing	YAR 214-2F
Housing	FYJ 514

MANUFACTURER

[SKF](#)

CALCULATION DATA

Basic dynamic load rating, C	62,400 kN
Basic static load rating, Co	44,000 kN
Fatigue load limit, Pu	1,860 kN
Limiting speed	2800 r/min