

FYJ 75 TF SKF

Ball bearing units

TYPE: Housing units, Four-bolt flanged housing units, Cast iron housing, Radial insert ball bearing with grub screws in inner ring, Type FY/FYJ..TF (SKF)

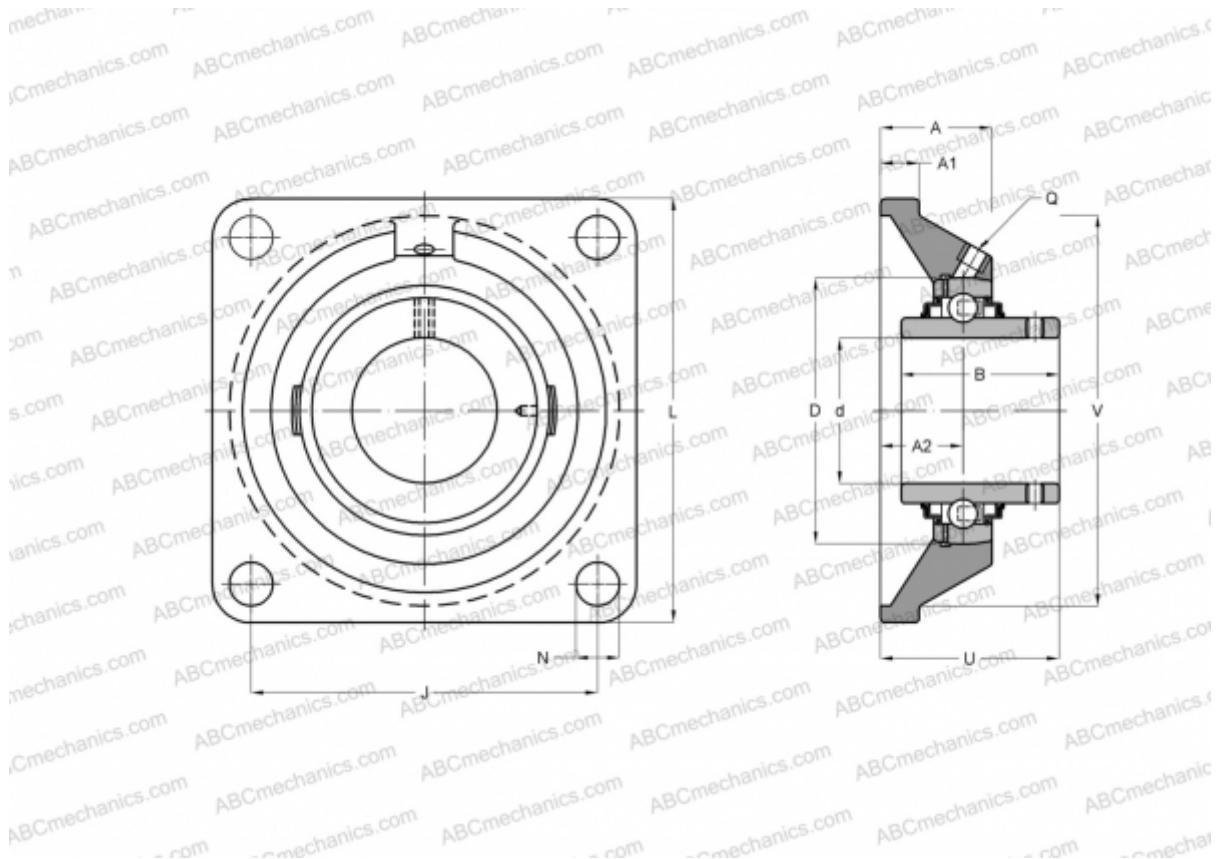

Technical specification

DIMENSIONS, MM

d	75,000
D	75,000
B	73,100
L	200,000
A	53,600
J	159,000
A1	22,100
N	19,000
U	80,100
V	179,400

WEIGHT, KG 6,800

Bearing	YAR 215-2F
Housing	FYJ 515

MANUFACTURER

[SKF](#)

CALCULATION DATA

Basic dynamic load rating, C	66,300 kN
Basic static load rating, Co	49,000 kN
Fatigue load limit, Pu	2,040 kN
Limiting speed	2600 r/min