

FYJ 80 TF SKF

Ball bearing units

TYPE: Housing units, Four-bolt flanged housing units, Cast iron housing, Radial insert ball bearing with grub screws in inner ring, Type FY/FYJ..TF (SKF)

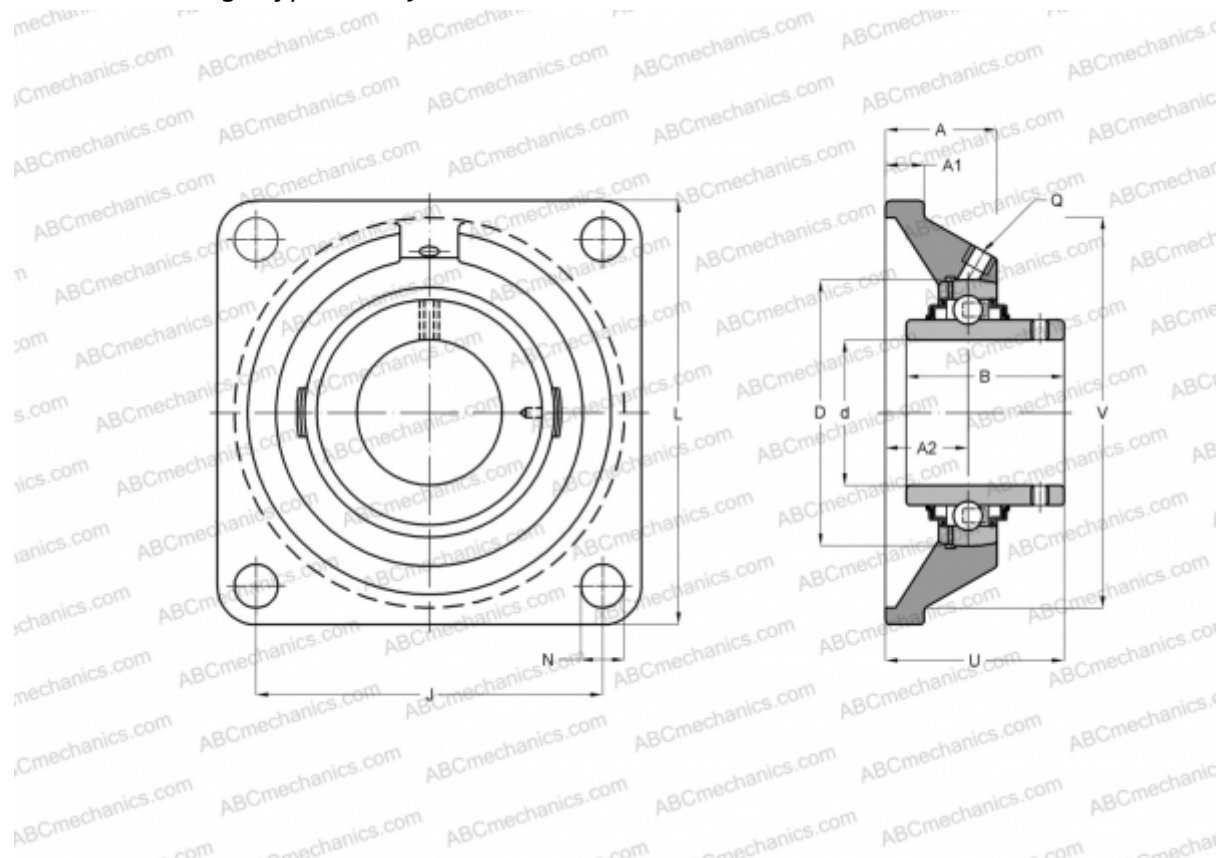

Technical specification

DIMENSIONS, MM

d	80,000
D	80,000
B	77,900
L	208,000
A	54,500
J	165,000
A1	22,000
N	23,000
U	81,700
V	179,400

WEIGHT, KG 7,600

Bearing	YAR 216-2F
Housing	FYJ 516

MANUFACTURER

[SKF](#)

CALCULATION DATA

Basic dynamic load rating, C	72,800 kN
Basic static load rating, Co	53,000 kN
Fatigue load limit, Pu	2,160 kN
Limiting speed	2400 r/min