

## FYJ 90 TF SKF

Ball bearing units

TYPE: Housing units, Four-bolt flanged housing units, Cast iron housing, Radial insert ball bearing with grub screws in inner ring, Type FY/FYJ..TF (SKF)

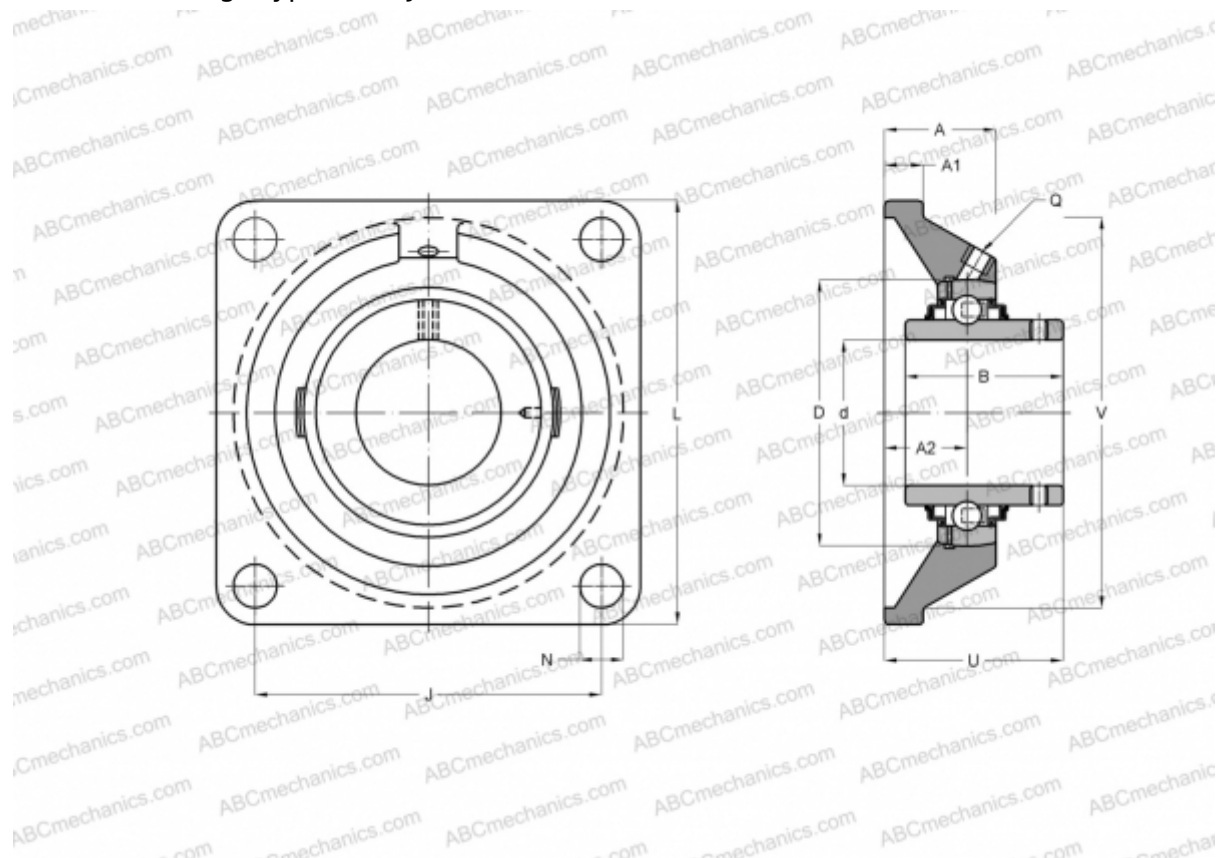

### Technical specification

#### DIMENSIONS, MM

d	90,000
D	90,000
B	89,000
L	235,000
A	63,400
J	187,000
A1	23,400
N	23,000
U	94,000
V	193,700

**WEIGHT, KG** 11,500

Bearing	YAR 218-2F
Housing	FYJ 518

#### MANUFACTURER

[SKF](#)

#### CALCULATION DATA

Basic dynamic load rating, C	95,600 kN
Basic static load rating, Co	72,000 kN
Fatigue load limit, Pu	2,700 kN
Limiting speed	2000 r/min