

## FY 20 TR SKF

Ball bearing units

TYPE: Housing units, Four-bolt flanged housing units, Cast iron housing, Radial insert ball bearing with grub screws in inner ring, Type FY..TR (SKF)

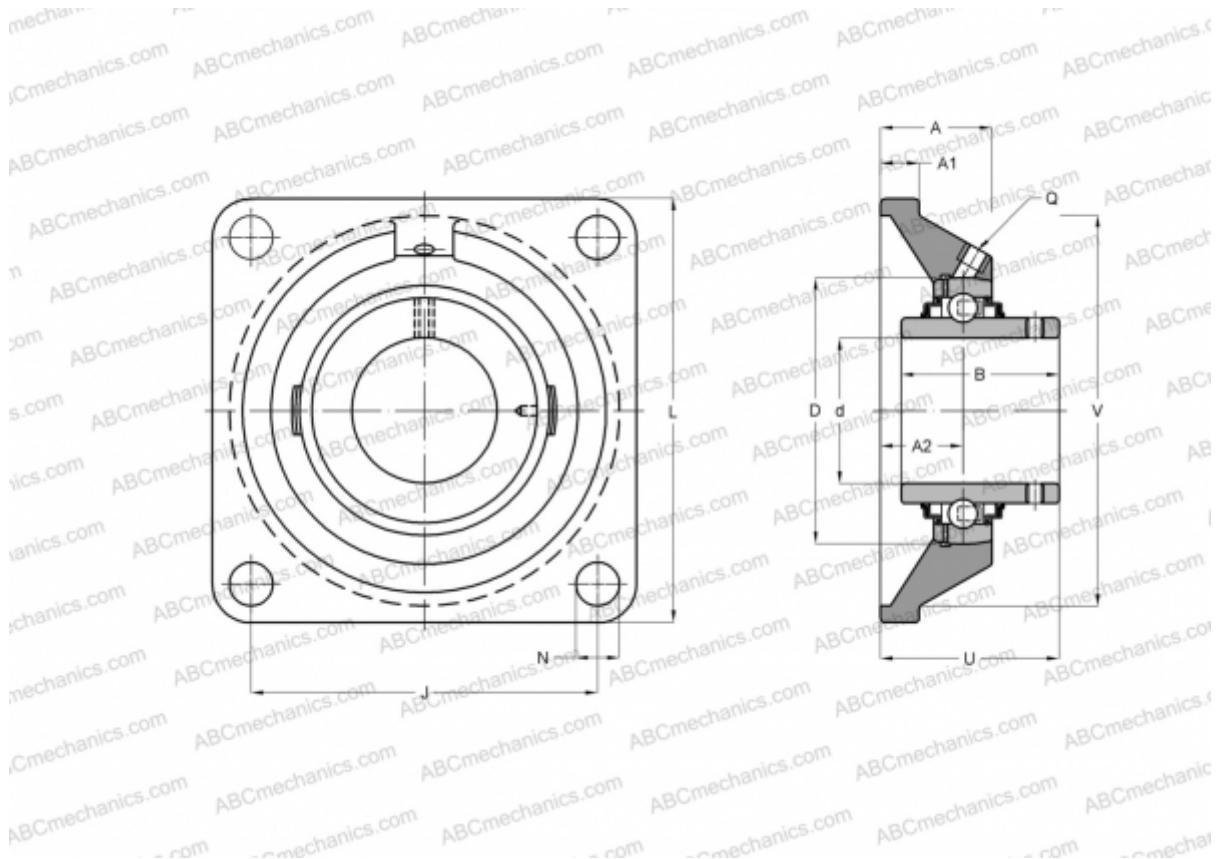

### Technical specification

#### DIMENSIONS, MM

d	20,000
D	20,000
B	31,000
L	86,000
A	29,500
J	63,500
A1	11,000
N	11,500
U	37,300
V	68,300

#### WEIGHT, KG

0,600

Bearing	YAR 204-2RF
Housing	FY 504 M

Protective cover

ECY 204

#### MANUFACTURER

[SKF](#)

#### CALCULATION DATA

Basic dynamic load rating, C	12,700 kN
Basic static load rating, Co	6,550 kN
Fatigue load limit, Pu	0,280 kN
Limiting speed	5000 r/min