

FY 25 TR SKF

Ball bearing units

TYPE: Housing units, Four-bolt flanged housing units, Cast iron housing, Radial insert ball bearing with grub screws in inner ring, Type FY..TR (SKF)

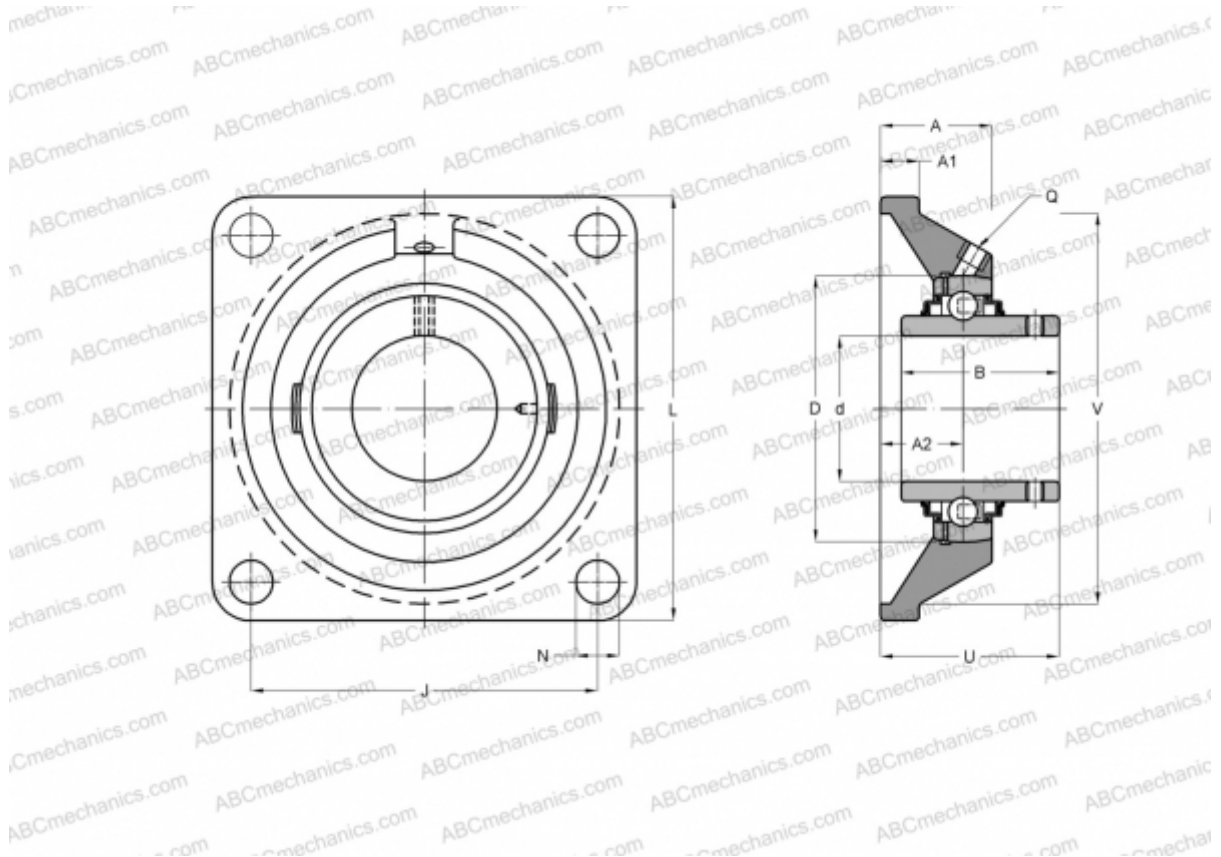

Technical specification

DIMENSIONS, MM

d	25,000
D	25,000
B	34,100
L	95,000
A	30,000
J	70,000
A1	12,000
N	11,500
U	38,800
V	74,600

WEIGHT, KG 0,770

Bearing	YAR 205-2RF
Housing	FY 505 M

Protective cover ECY 205

MANUFACTURER

[SKF](#)

CALCULATION DATA

Basic dynamic load rating, C	14,000 kN
Basic static load rating, Co	7,800 kN
Fatigue load limit, Pu	0,335 kN
Limiting speed	4300 r/min