

FY 35 TR SKF

Ball bearing units

TYPE: Housing units, Four-bolt flanged housing units, Cast iron housing, Radial insert ball bearing with grub screws in inner ring, Type FY..TR (SKF)

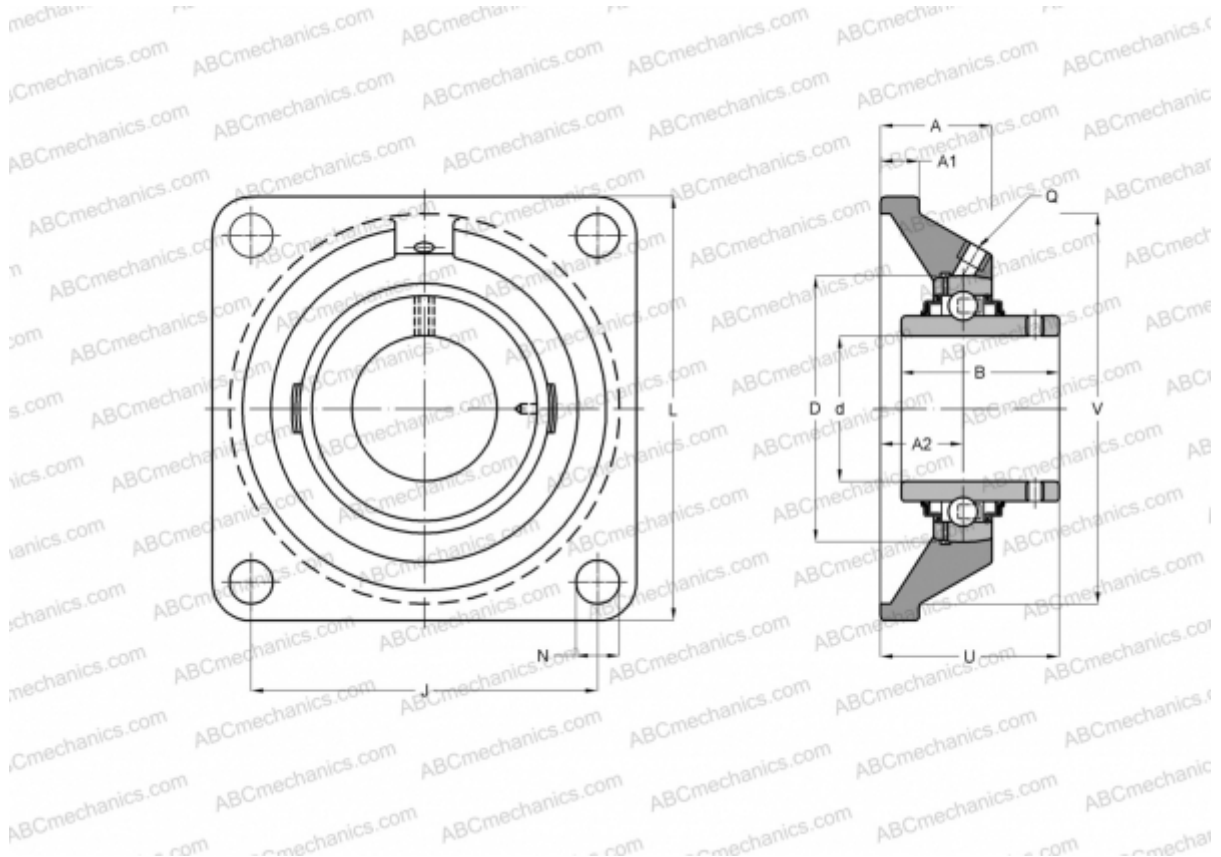

Technical specification

DIMENSIONS, MM

d	35,000
D	35,000
B	42,900
L	118,000
A	34,500
J	92,000
A1	13,000
N	14,000
U	46,400
V	106,400

WEIGHT, KG

1,400

Bearing	YAR 207-2RF
Housing	FY 507 M

Protective cover

ECY 207

MANUFACTURER

[SKF](#)

CALCULATION DATA

Basic dynamic load rating, C	25,500 kN
Basic static load rating, Co	15,300 kN
Fatigue load limit, Pu	0,655 kN
Limiting speed	3200 r/min