

FY 45 TR SKF

Ball bearing units

TYPE: Housing units, Four-bolt flanged housing units, Cast iron housing, Radial insert ball bearing with grub screws in inner ring, Type FY..TR (SKF)

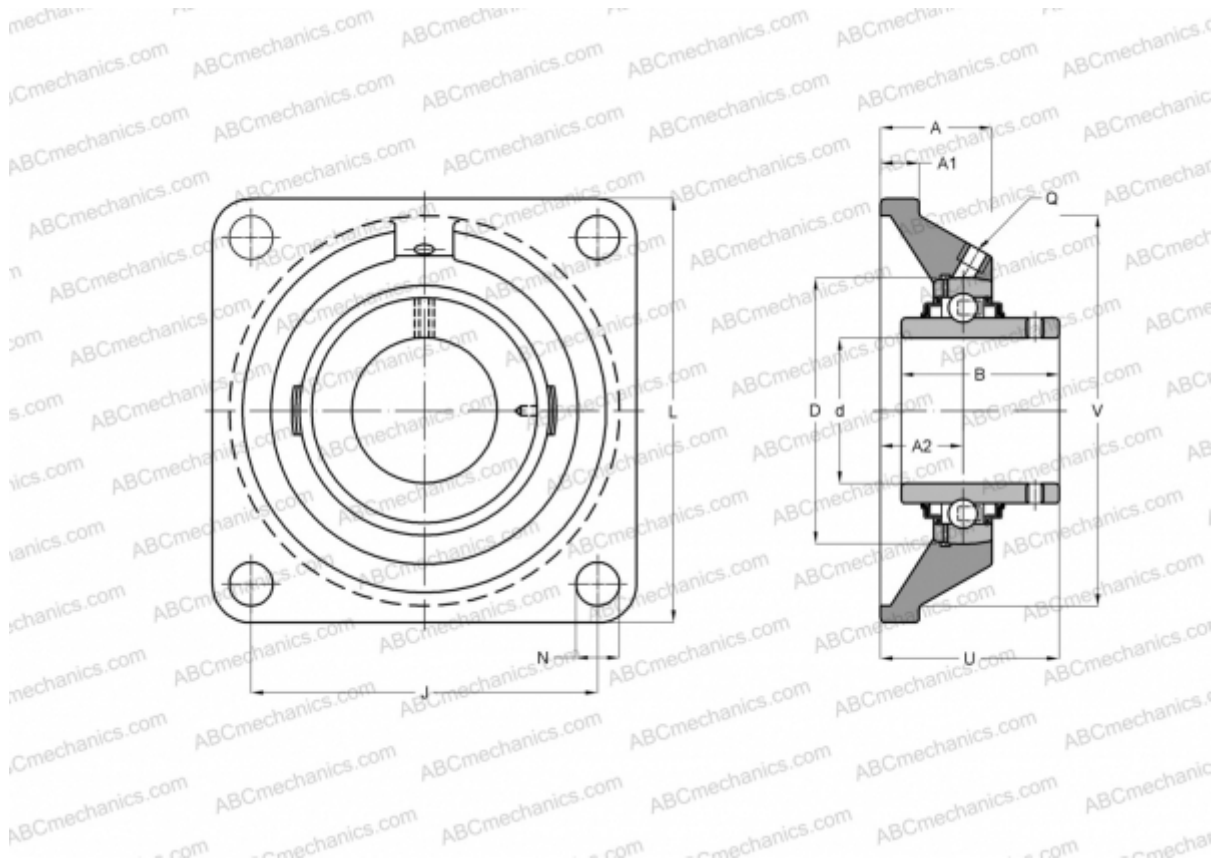

Technical specification

DIMENSIONS, MM

d	45,000
D	45,000
B	49,200
L	137,000
A	39,000
J	105,000
A1	14,000
N	16,000
U	54,200
V	119,100

WEIGHT, KG

2,100

Bearing	YAR 209-2RF
Housing	FY 509 M

Protective cover

ECY 209

MANUFACTURER

[SKF](#)

CALCULATION DATA

Basic dynamic load rating, C	33,200 kN
Basic static load rating, Co	21,600 kN
Fatigue load limit, Pu	0,915 kN
Limiting speed	2400 r/min