

FY 55 TR SKF

Ball bearing units

TYPE: Housing units, Four-bolt flanged housing units, Cast iron housing, Radial insert ball bearing with grub screws in inner ring, Type FY..TR (SKF)

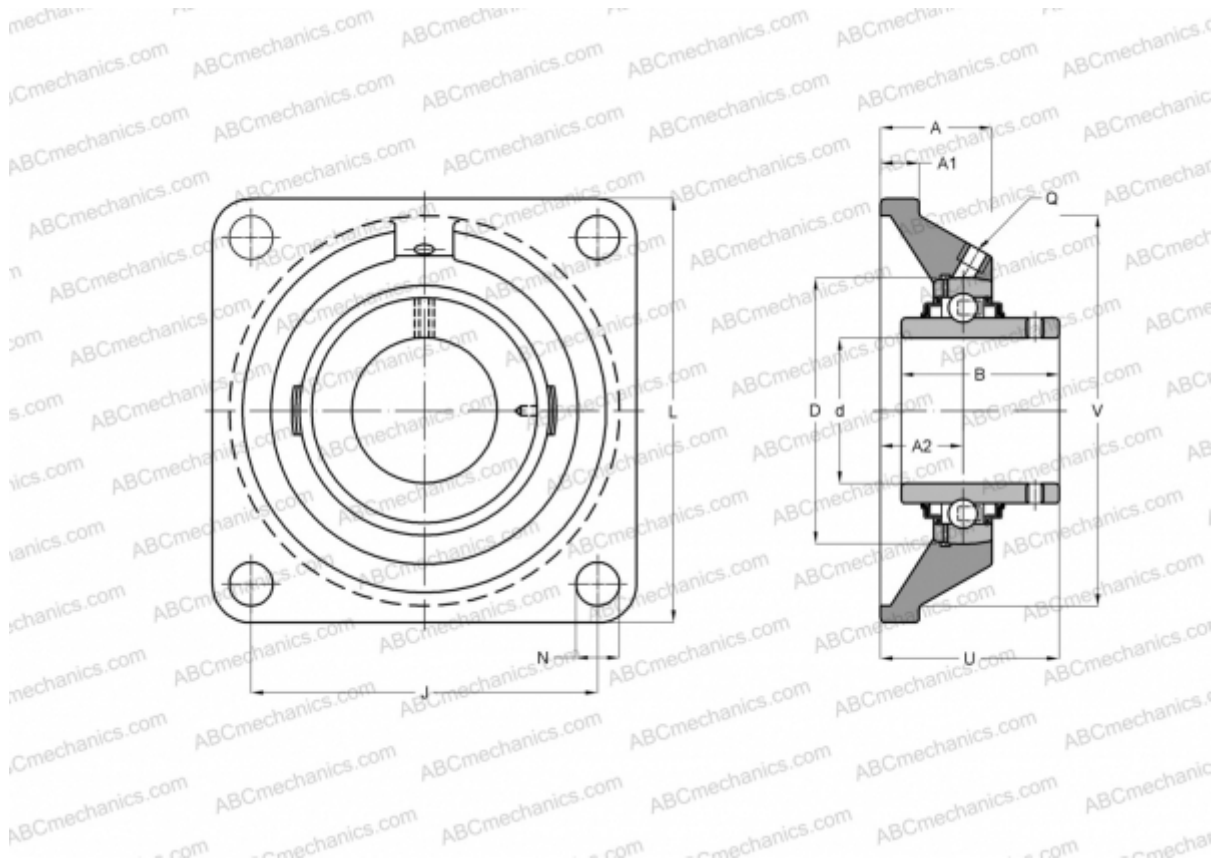

Technical specification

DIMENSIONS, MM

d	55,000
D	55,000
B	55,600
L	162,000
A	47,500
J	130,000
A1	16,000
N	18,000
U	64,400
V	150,800

WEIGHT, KG

3,600

Bearing	YAR 211-2RF
Housing	FY 511 M

Protective cover

ECY 211

MANUFACTURER

[SKF](#)

CALCULATION DATA

Basic dynamic load rating, C	43,600 kN
Basic static load rating, Co	29,000 kN
Fatigue load limit, Pu	1,250 kN
Limiting speed	1900 r/min