

FY 60 TR SKF

Ball bearing units

TYPE: Housing units, Four-bolt flanged housing units, Cast iron housing, Radial insert ball bearing with grub screws in inner ring, Type FY..TR (SKF)

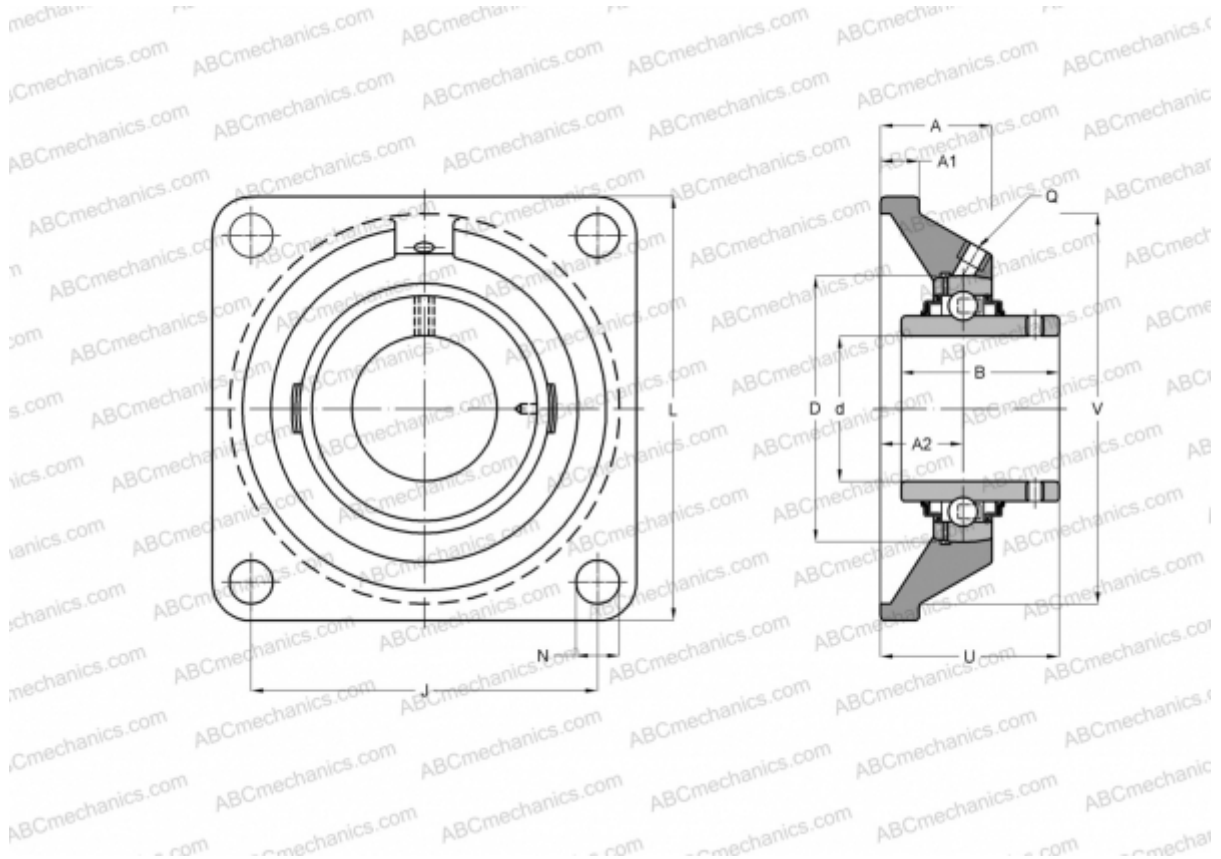

Technical specification

DIMENSIONS, MM

d	60,000
D	60,000
B	65,100
L	175,000
A	52,000
J	143,000
A1	17,000
N	18,000
U	73,700
V	161,900

WEIGHT, KG

4,600

Bearing	YAR 212-2RF
Housing	FY 512 M

Protective cover

ECY 212

MANUFACTURER

[SKF](#)

CALCULATION DATA

Basic dynamic load rating, C	52,700 kN
Basic static load rating, Co	36,000 kN
Fatigue load limit, Pu	1,530 kN
Limiting speed	1800 r/min