

FY 1/2 TF SKF

Ball bearing units

TYPE: Housing units, Four-bolt flanged housing units, Cast iron housing, Radial insert ball bearing with grub screws in inner ring, Type FY/FYJ/FYM..TF (SKF), inch

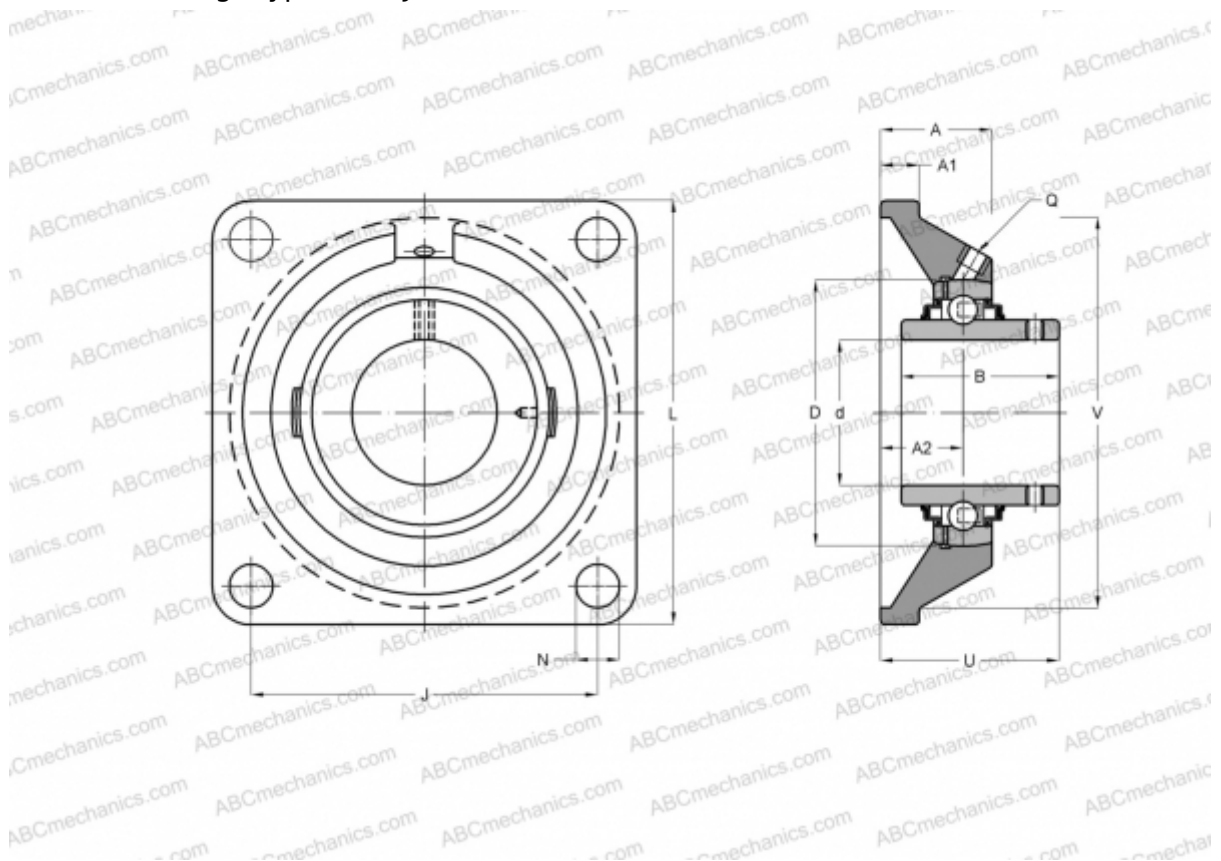

Technical specification

DIMENSIONS, MM

d	12,700
D	40,000
B	27,400
L	76,200
A	23,400
J	54,000
A1	9,900
A2	14,700
U	30,600

WEIGHT, KG 0,460

Bearing	YAR 203-008-
Housing	FY 503 U

MANUFACTURER

[SKF](#)

CALCULATION DATA

Basic dynamic load rating, C	9,560 kN
Basic static load rating, Co	4,750 kN
Fatigue load limit, Pu	0,200 kN
Limiting speed	9500 r/min