

## FY 7/8 TF SKF

Ball bearing units

TYPE: Housing units, Four-bolt flanged housing units, Cast iron housing, Radial insert ball bearing with grub screws in inner ring, Type FY/FYJ/FYM..TF (SKF), inch

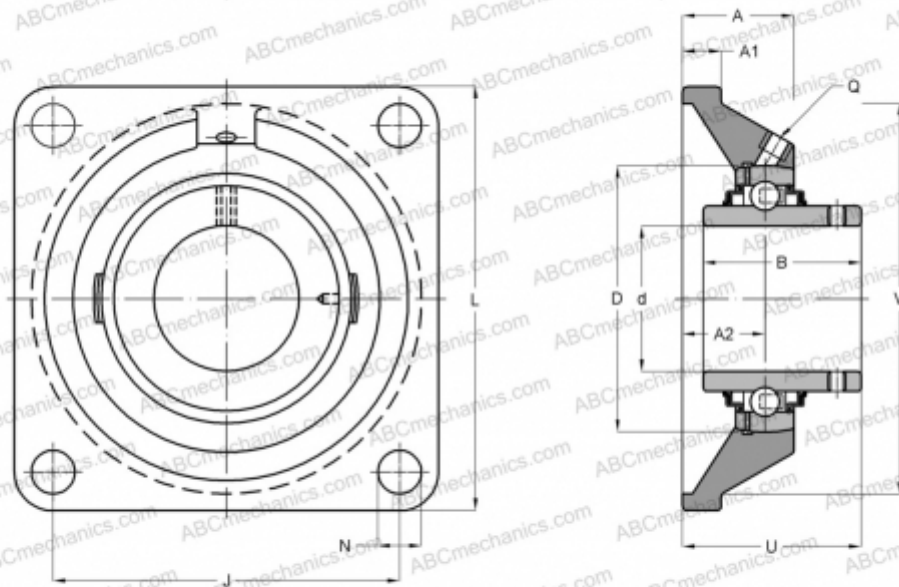

### Technical specification

#### DIMENSIONS, MM

d	22,225
D	52,000
B	34,100
L	95,000
A	30,000
J	70,000
A1	12,000
A2	19,000
U	38,800

**WEIGHT, KG** 0,800

Bearing	YAR 205-014-
Housing	FY 505 U

#### MANUFACTURER

[SKF](#)

#### CALCULATION DATA

Basic dynamic load rating, C	14,000 kN
Basic static load rating, Co	7,800 kN
Fatigue load limit, Pu	0,335 kN
Limiting speed	7000 r/min