

FY 1.3/16 TF SKF

Ball bearing units

TYPE: Housing units, Four-bolt flanged housing units, Cast iron housing, Radial insert ball bearing with grub screws in inner ring, Type FY/FYJ/FYM..TF (SKF), inch

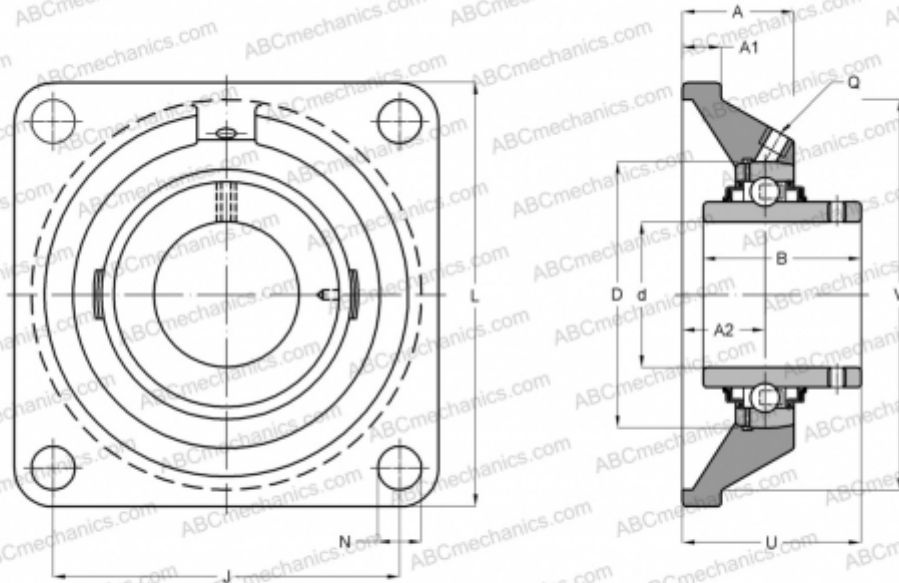

Technical specification

DIMENSIONS, MM

d	30,163
D	62,000
B	38,100
L	108,000
A	32,500
J	82,500
A1	13,000
A2	20,000
U	42,200

WEIGHT, KG 1,100

Bearing	YAR 206-103-
Housing	FY 506 U

MANUFACTURER

[SKF](#)

CALCULATION DATA

Basic dynamic load rating, C	19,500 kN
Basic static load rating, Co	11,200 kN
Fatigue load limit, Pu	0,475 kN
Limiting speed	6300 r/min