

FY 1.1/4 TF SKF

Ball bearing units

TYPE: Housing units, Four-bolt flanged housing units, Cast iron housing, Radial insert ball bearing with grub screws in inner ring, Type FY/FYJ/FYM..TF (SKF), inch

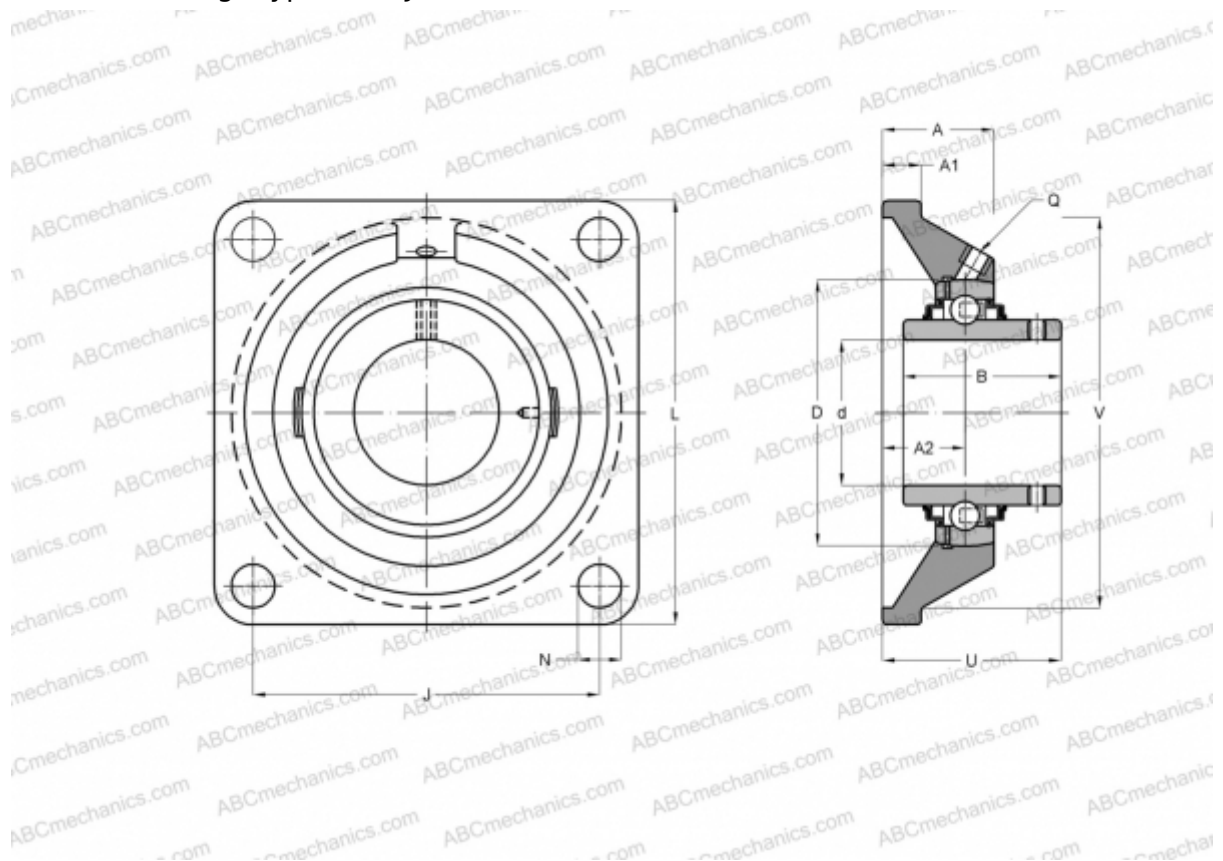

Technical specification

DIMENSIONS, MM

d	31,750
D	72,000
B	42,900
L	118,000
A	34,500
J	92,000
A1	13,000
A2	21,000
U	46,400

WEIGHT, KG 1,450

Bearing	YAR 207-104-
Housing	FY 507 M

MANUFACTURER

[SKF](#)

CALCULATION DATA

Basic dynamic load rating, C	25,500 kN
Basic static load rating, Co	15,300 kN
Fatigue load limit, Pu	0,655 kN
Limiting speed	5300 r/min