

## FYM 1.7/16 TF SKF

Ball bearing units

TYPE: Housing units, Four-bolt flanged housing units, Cast iron housing, Radial insert ball bearing with grub screws in inner ring, Type FY/FYJ/FYM..TF (SKF), inch

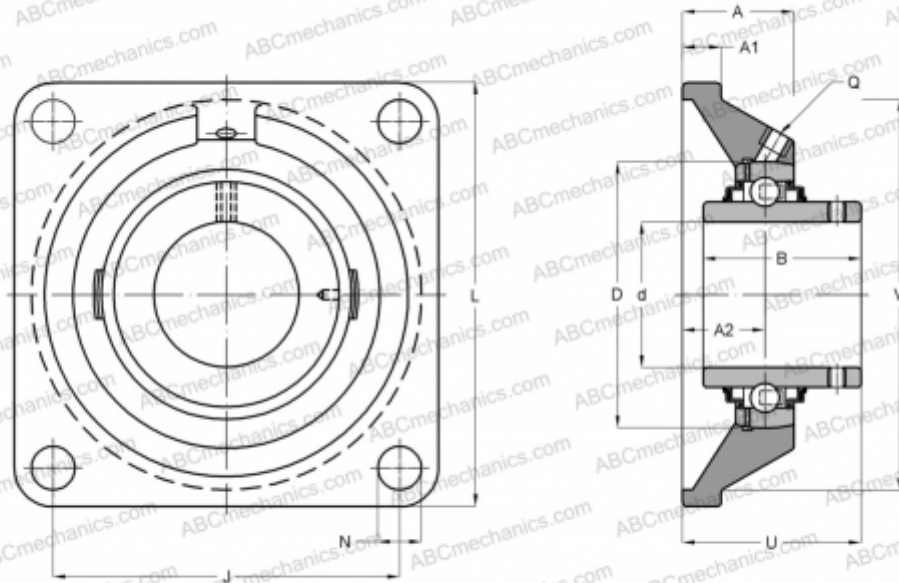

### Technical specification

#### DIMENSIONS, MM

d	36,513
D	80,000
B	49,200
L	130,000
A	38,500
J	101,500
A1	14,000
A2	24,000
U	54,200

**WEIGHT, KG** 2,000

Bearing	YAR 208-107-
Housing	FY 508 U

#### MANUFACTURER

[SKF](#)

#### CALCULATION DATA

Basic dynamic load rating, C	30,700 kN
Basic static load rating, Co	19,000 kN
Fatigue load limit, Pu	0,800 kN
Limiting speed	4800 r/min